



Trusted Signage Supplier

PRODUCT CATALOGUE



SIGNAGE SUPPLIES

EXHIBITION & EVENT

DISPLAY & PRINTING

1300 550 168

sales@bigbanner.com.au



OUR PROCESS

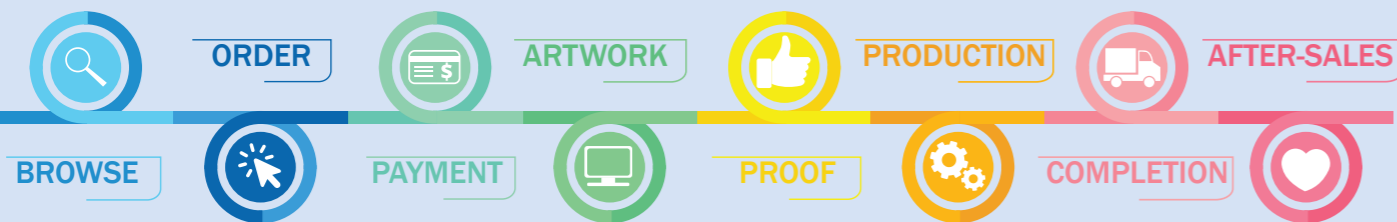

*All prices in this catalogue are GST EXCLUSIVE.
Prices are subject to change without notice. BBA reserves all rights for final explanation.

BIG BANNER AUSTRALIA

Your Trusted Partner in Signage Solutions

Big Banner Australia provides a seamless **one-stop shop experience** for businesses of all sizes, delivering end-to-end services in signage, printing, events and exhibition displays, promotional gifts, and marketing needs. As a **manufacturer, wholesaler, and importer**, we combine versatility with competitive value to meet diverse requirements.

With **20+ years of expertise** in manufacturing, customer service and logistics, we pride ourselves on reliability, quality, and efficiency. BBA is rooted in a culture of **ethics, dedication, mutual respect, and innovation**, ensuring every project aligns with the highest standards. Our customers and clients are at the core of everything we create and do. We continue to strive to always exceed their expectations.

THINK BIGGER is more than a motto to Big Banner Australia – it is our vision.

1 | Business Signage

P1-24



4 | Exhibition & Event

P31-58



2 | Sign Accessories

P25-26



5 | Display & Printing

P59-78

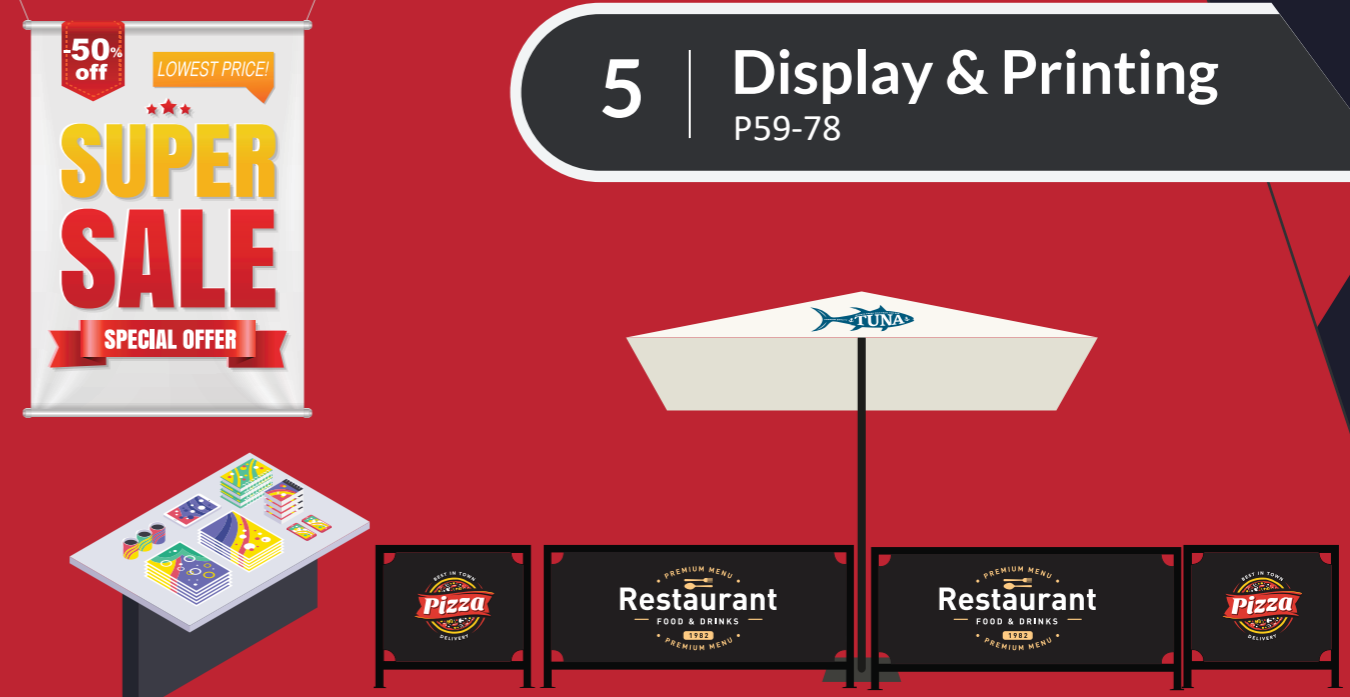

3 | Equipment & Tools

P27-30

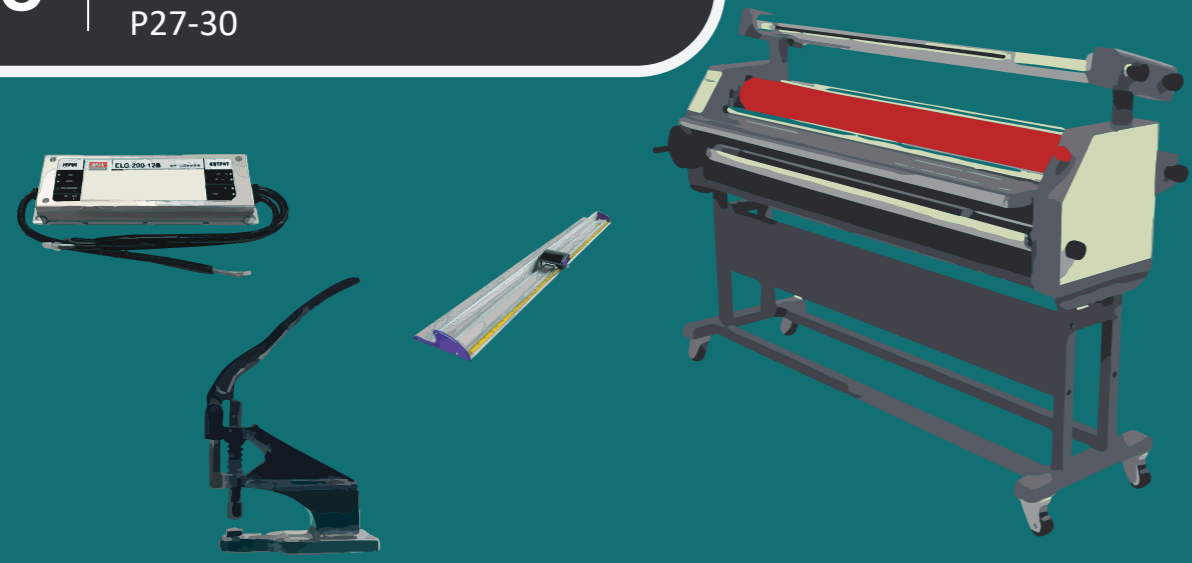

6 | Promotional Gifts

P79-84



INFINITY



Business Signage

Please prepare below information when you need a quote:



Draft of design with dimensions marked, if not available, provide contents (letters, logo, font, size of space where the sign will be installed).



Interior or Exterior?



Non-Lit or Illuminated?



Deadline (if applicable)



Installation Information

- (1) Where
- (2) Current condition for installation point
- (3) Distance from ground

With the above information, a quote/proposal will be provided within 12 working hours.



3D Signage

Acrylic Fabricated LED Channel Letters 3D-027

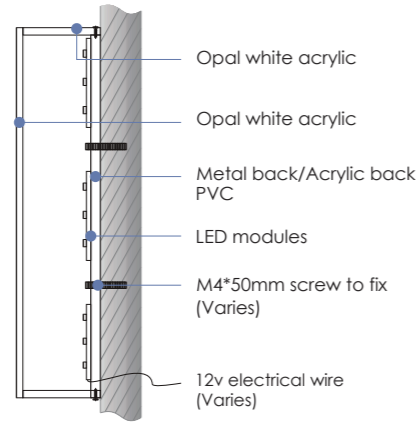

Face & Body: Acrylic fabrication/20mm opal acrylic engraved
Finish: Glue sealed, 2 pac paint on face or plain colour acrylic/stainless steel face/UV PVC
Back: Enclosed with 3mm acrylic or metal panel
Illumination: LED modules, 3,000k ~ 10,000k (Dimmer available at extra cost)
Installation: Installation template included, stand-off bolts/screws or flush mounting
Power supply: 12v-240v Meanwell transformer/C-tick Certified
Colour/Size/Shape: Customized

Back-Illuminated Acrylic Letters 3D-026

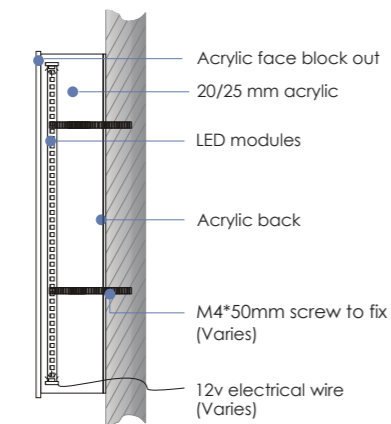

Face: 3mm solid acrylic block out with colour
Body: 3mm acrylic fabrication
Option: 25mm solid acrylic engraved
Finish: Glue sealed, 2 pac paint on face or plain colour acrylic/stainless steel face/UV PVC
Back: Enclosed with 3mm acrylic
Illumination: LED modules, 3,000k ~ 10,000k (Dimmer available at extra cost)
Installation: Installation template included, stand-off bolts/screws or flush mounting
Power supply: 12v-240v Meanwell transformer/C-tick Certified
Colour/Size/Shape: Customized

Stainless Steel Letters with LED Back Illumination 3D-1002

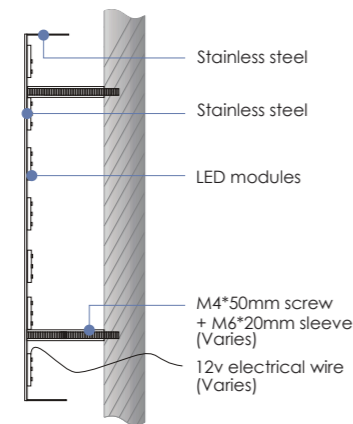

Face & Body: 1mm stainless steel (304/316 grade) fabricated
Options: Thickness 1mm/2mm/3mm, etc.
Finish: Plain silver, polished/brushed, electrical plated, powder coated, aged/rusty, UV printed, etc.
Back: Open/acrylic enclosed
Illumination: LED modules, 3,000k~10,000k (Dimmer available at extra cost)
Installation: Installation template included, stand-off bolts/screws or flush mounting
Power supply: 12v-240v Meanwell transformer/C-tick Certified
Colour/Size/Shape: Customized

Face Illuminated Rimless LED Letters 3D-007

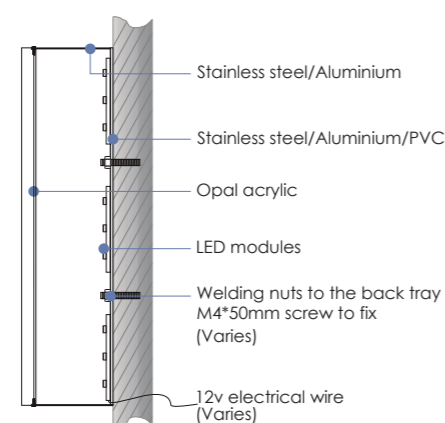

Face: 3mm / 4.5mm / 6mm Acrylic
Body: 1mm stainless steel (304/316 grade) fabricated/Aluminium
Thickness Option: 1mm / 2mm / 3mm
Finish: Plain silver, polished/ brushed, electrical plated, powder coated, digital printed, etc.
Back: Metal base /PVC backing
Illumination: LED modules, 3,000 ~ 10,000k (Dimmer available at extra cost)
Installation: Installation template included, stand-off bolts/screws or flush mounting
Power supply: 12v-240v Meanwell transformer/C-tick Certified
Colour/Size/Shape: Customized

3D Signage

Engraved Acrylic Letters with LED Illumination Mini-L

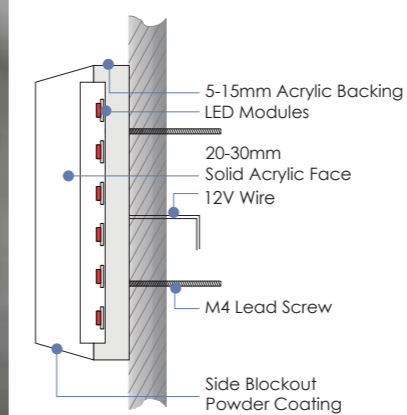

Face & Body: 25mm/20mm solid acrylic engraved
Lighting method: Face + rear side illumination, side block out (colour painted TBC)
Back: 3mm/5mm/7mm acrylic back with illumination
Illumination: LED modules, 3,000k ~ 10,000k (Dimmer available at extra cost)
Installation: Installation template included, stand-off bolts/screws or flush mounting
Power supply: 12v-240v Meanwell transformer/C-tick Certified
Colour/Size/Shape: Customized

Metal Fabricated Letters with Halo LED 3D-006

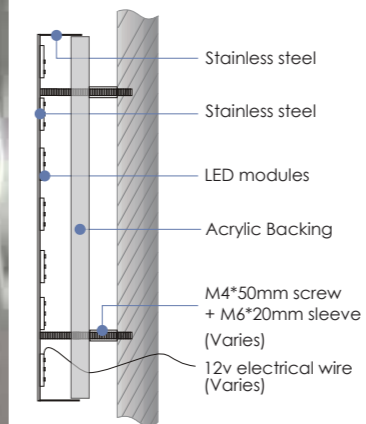

Material: 1mm stainless steel (304/316 grade) fabricated
Options: Thickness 1mm/2mm/3mm, etc.
Face: Polished mirror stainless steel
Options: brushed, aged copper, powder coated, UV
Illumination: LED modules, 3,000k ~ 10,000k (Dimmer available at extra cost)
Installation: Installation template included, stand-off bolts/screws or flush mounting
Power supply: 12v-240v Meanwell transformer/C-tick Certified
Colour/Size/Shape: Customized

Face Illuminated Channel Letter 3D-005

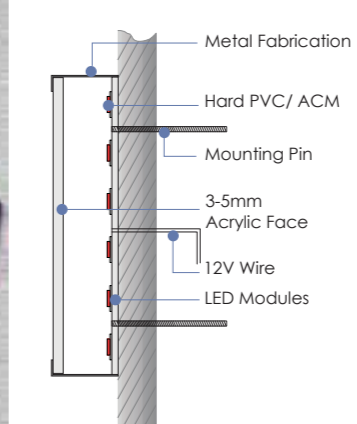

Face: 3mm / 4.5mm Acrylic
Body: 1mm 304 grade stainless steel fabricated (Option: 316 Marine Grade / Aluminium)
Finish: Plain silver, polished / brushed, electrical plated, powder coated, UV printed, etc.
Back: Metal base/PVC
Illumination: LED modules 3,000K ~10,000K (Dimmer available at extra cost)
Installation: Installation template included, stand-off bolts/screws or flush mounting
Power Supply: 12v-240v Meanwell transformer/C-tick Certified
Colour/Size/Shape: Customized

LED Bulbs Marquee Letters 3D-95

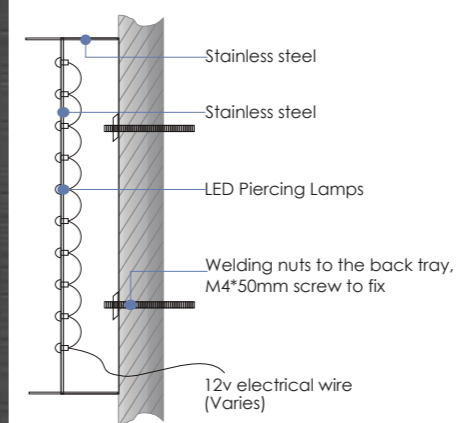

Material: 1mm stainless steel (304/316 grade) fabricated
Finish: Powder coated or Plating into metallic colour
Back: Stainless steel enclose PVC backing
Illumination: LED modules, 3,000k ~ 10,000k (Dimmer available at extra cost)
Installation: Installation template included stand-off bolts/screws or flush mounting
Power supply: 12v-240v Meanwell transformer/C-tick Certified
Colour/Size/Shape: Customized

3D Signage

Customized LED Flex Neon Sign Neon-1



Material: PVC/Rubber Tube (internal use only)
Diameter: 6mm/8mm/12mm
Installation: supplied with acrylic backing panel, metal panel, metal frame. Hanging system available by special request.
Power Supply: 12v/24v-240v Meanwell transformer/C-tick Certified
Colour/Size/Shape: Customized

Acrylic Engraved Curved LED Neon Sign Neon-3



Material: Cast Acrylic
Face & Body: 15mm-25mm solid acrylic engraved for LED module filling
Back: Metal/ABS
Finish: Face illumination, side block out (colour painted TBC)
Illumination: 6,500k LED face illuminated
Installation: installation template included, flush mounting
Power supply: 12v-240v, C-Tick Meanwell transformer
Colour/Size/Shape: Customized

Embossed Antique Brass Metal Custom-made Sign Plaques Msign-EM



- Custom-made antique brass metal emblem plaques, zinc alloy, vintage antique, brass plated metal sign board, name plates, emblem plaques
- Material and process including zinc alloy, die casting, polishing, antique brass plated
- Logo embossed with antique, vintage, gold or silver color effects
- Customized made to your requirement

LED Rimless Resin Letters 3D-Resin



Face: 8mm-10mm Liquid acrylic / resin
Body: 1mm 304 grade stainless steel fabricated (Option: 316 Marine Grade)
Back: Metal base
Finish: Plain silver, polished / brushed, electrical plated
Illumination: LED modules, 3,000k ~ 10,000k (Dimmer available at extra cost)
Installation: Installation template included, stand-off bolts/screws or flush mounting
Power supply: 12v-240v Meanwell transformer/C-tick Certified
Colour/Size/Shape: Customized

3D Signage

Stainless Steel Channel Letters 3D-001



Face & Body: 1mm stainless steel (304/316 grade) fabricated
Options: Thickness 1mm/2mm/3mm, etc.
Finish: Plain silver, polished/brushed, electrical plated, powder coated, aged/rusty, UV printed, etc.
Back: Open/PVC Backing
Illumination: N/A
Installation: Installation template included, stand-off bolts/screws or flush mounting.
Colour/Size/Shape: Customized

Flat Cut Letters SS-S2



Face & Body: 1mm, 2mm, 3mm... 6mm, etc. Aluminum, Iron, Brass, Copper, Stainless Steel, etc. 304/316 grade stainless steel
Illumination: N/A
Installation: Installation template included, stand-off bolts/screws or flush mounting.
Colour/Size/Shape: Customized

Cylinder 3D Metal Letters 3D-CYLINDER



Materials & Finishes: Aluminum/Brass - 2pac painting, powder coated, oxidised
Face & Body: 3/5/8/10/15/20/25/30mm
Illumination: N/A
Installation: Installation template included, stand-off bolts/screws or flush mounting.
Colour/Size/Shape: Customized

Acrylic Routed Letters 3D-098



Face & Body: 3mm ~ 25mm acrylic routed/laser cut
Finish: UV print/2 Pac paint/Plain colour
Illumination: N/A
Installation: Installation template included, stand-off bolts/screws or flush mounting
Colour/Size/Shape: Customized

3D Signage

Push Through Style LED Light Box LB-PT



Customizable: Allows for a wide range of custom designs, including different fonts, sizes, and styles of letters or graphics

Durability: The use of durable materials and LED lighting ensures long-lasting performance

Even Illumination: Ensures even light distribution across the letters or graphics, reducing hot spots and creating a consistent, visually pleasing effect

Energy Efficiency: Use LED lighting, which is energy-efficient and has a long lifespan

Easy Maintenance: Can be easily replaced or updated without the need to disassemble the entire light box

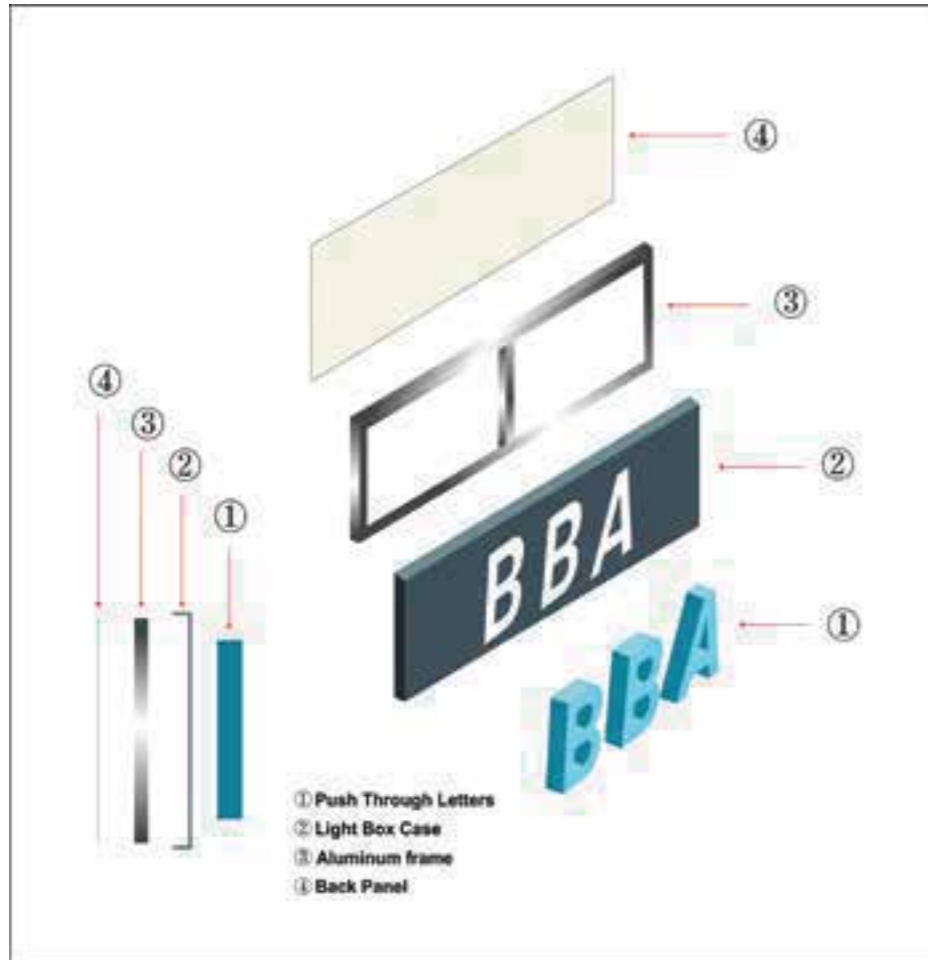

Acrylic Signs

Acrylic Panel – Sign Board AS-002



- Floating 1 -2 cm away from the wall, frameless with a sharp look
- Suitable for all types of images such as wedding photos, family or single portraits, etc.
- Full colour high definition print
- Made from quality acrylic panels
- Come with aluminum standoffs for installation (4 -6 units)
- Customized sizes available
- Thickness options: 3mm, 4.5mm, 6mm, 10mm



Size	Thickness	Price
600 x 800mm	4.5mm	\$285
600 x 1200mm	4.5mm	\$385
900 x 1500mm	4.5mm	\$589
600 x 800mm	6.0mm	\$349
600 x 1200mm	6.0mm	\$439
900 x 1500mm	6.0mm	\$689

For alternate sizing, please contact one of our friendly team.

Acrylic Light Box Panel AS-LB



- Full colour high resolution printing
- UV and water resistant suitable for outdoor use
- Cost effective for re-branding, changing image, etc.
- Customized sizes available to suit your existing light box
- Thickness options: 3mm, 4.5mm, 6mm

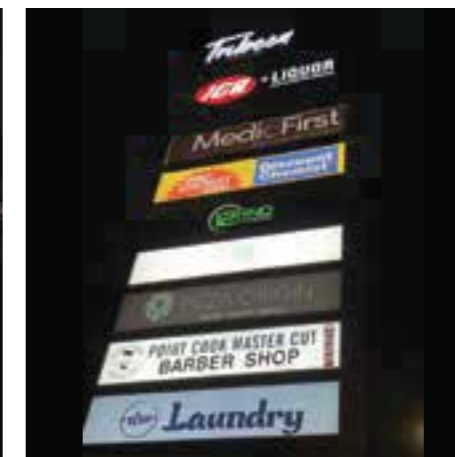

Size	Thickness	Price
400 x 1200mm	3.0mm	\$120
400 x 1800mm	3.0mm	\$150
600 x 2000mm	3.0mm	\$220
600 x 2440mm	3.0mm	\$240
400 x 1200mm	4.5mm	\$150
400 x 1800mm	4.5mm	\$200
600 x 2000mm	4.5mm	\$260
600 x 2440mm	4.5mm	\$300

Please contact us for size or thickness not listed above.

Metal Signage

Aluminum Composite Panel Sign Msign-01



Size	Price
600 x 900mm	\$90
900 x 1200mm	\$150
1200 x 1500mm	\$250
2440 x 1220mm	\$340
3050 x 1500mm	\$520

Customized sizes available

Real Estate For Sale | For Lease Sign Board | Ready To Go Sign Msign-R-1

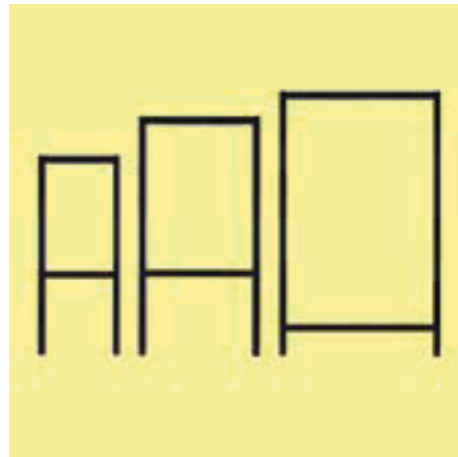

Star Pickets/Free Standing Feet

Size	Overall Height	Single Side Print	Double Side Print
600 x 900mm	1500mmH	\$240	\$360
900 x 1200mm	1800mmH	\$360	\$490
1200 x 1800mm	2000mmH	\$480	\$690

- Created in pieces, simple to assemble and easy to transport
- Made of powder coated 50mm square steel tube
- Ideal for outdoor signage, such as real estate, cafes and restaurants, local stores, councils (public areas)
- Base options: Spikes/Star Pickets \$50; Free Standing Feet \$60

Metal Signage

ACM Fabricated Sign Boxes

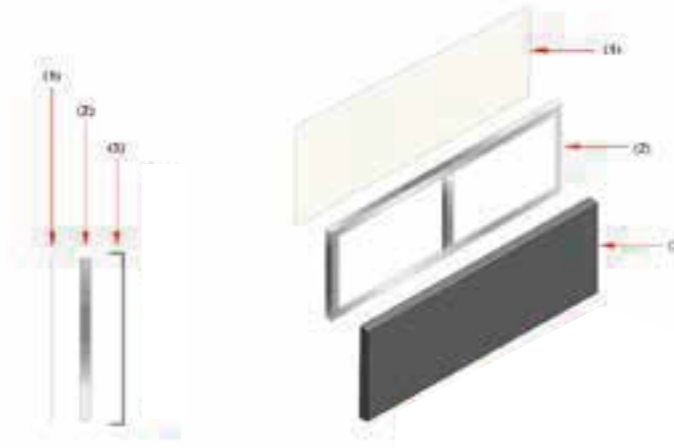
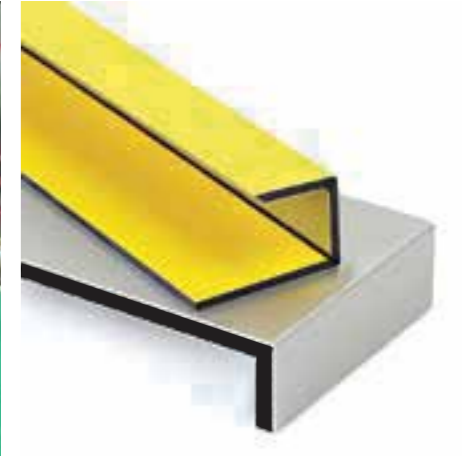

- Aluminium frame wrapped with composite panel
- Folded on edges with v-groove cut
- Screws on the return with no visible fixing on face
- Full colour print or raised logo on the face
- Great choice for illuminated signs which allows wires to run inside

Routed Aluminium Signs



- Custom-made by CNC router
- 3mm thickness sturdy aluminum composite metal sheet
- High resolution printed vinyl or 3D signs mounted on panel
- Weather tolerant & UV resistant
- Great for outdoor or indoor use
- Full panel size available in 1220 x 2440mm from \$360 each panel
- Cost varies with the complexity of designs

Panel Size	Price
1200 x 800mm	\$150
1200 x 1200mm	\$240
1200 x 1800mm	\$300

Single-sided Aluminium Light Box



LB-SS-S



LB-SS-L



LB-SS

LB-SS-S Size	Hardware Only	With Printing	LB-SS-L Size	Hardware Only	With Printing
500 x 400mm	\$475	\$575	1200 x 400mm	\$575	\$725
500 x 500mm	\$490	\$590	1200 x 500mm	\$610	\$760
600 x 400mm	\$480	\$590	1200 x 600mm	\$650	\$800
600 x 500mm	\$500	\$600	1200 x 700mm	\$700	\$860
600 x 600mm	\$525	\$630	1200 x 800mm	\$775	\$925
700 x 400mm	\$500	\$610	1200 x 1200mm	\$930	\$1045
700 x 500mm	\$540	\$640	1500 x 400mm	\$700	\$880
700 x 600mm	\$650	\$660	1500 x 500mm	\$730	\$920
700 x 700mm	\$590	\$700	1500 x 600mm	\$775	\$960
800 x 400mm	\$510	\$630	1500 x 700mm	\$840	\$1025
800 x 500mm	\$630	\$690	1500 x 800mm	\$910	\$1090
800 x 600mm	\$580	\$680	1800 x 400mm	\$830	\$1030
800 x 700mm	\$600	\$725	1800 x 500mm	\$870	\$1070
800 x 800mm	\$640	\$760	1800 x 600mm	\$920	\$1120
900 x 400mm	\$530	\$660	1800 x 700mm	\$990	\$1190
900 x 500mm	\$560	\$690	1800 x 800mm	\$1070	\$1270
900 x 600mm	\$580	\$710	2000 x 400mm	\$1000	\$1220
900 x 700mm	\$610	\$745	2000 x 500mm	\$1060	\$1260
900 x 800mm	\$660	\$790	2000 x 600mm	\$1110	\$1325
900 x 900mm	\$770	\$840	2000 x 700mm	\$1190	\$1410
1000 x 400mm	\$550	\$590	2000 x 800mm	\$1275	\$1490
1000 x 500mm	\$575	\$710	2200 x 400mm	\$1060	\$1310
1000 x 600mm	\$600	\$740	2200 x 500mm	\$1110	\$1360
1000 x 700mm	\$650	\$790	2200 x 600mm	\$1160	\$1410
1000 x 800mm	\$700	\$840	2400 x 400mm	\$1120	\$1375
1000 x 900mm	\$750	\$890	2400 x 500mm	\$1165	\$1425
1000 x 1000mm	\$790	\$930	2400 x 600mm	\$1220	\$1475
			3000 x 400mm	\$1660	\$1900
			3000 x 600mm	\$1870	\$1710
			3000 x 800mm	\$2180	\$2750

Aluminium fabricated frame with black powder coating (customized colour at extra cost)
150mm depth box frame | LED lighting source | 3mm/4.5mm opal acrylic face panel | Hanging bracket 1200mm at \$135/ pair.

Double-sided Aluminium Light Box



LB-SQ



LB-SQ

LB-SQ Size	Hardware Only	With Printing	With Bracket
400 x 400mm	\$440	\$575	\$710
400 x 600mm	\$480	\$620	\$755
500 x 500mm	\$490	\$640	\$775
600 x 600mm	\$510	\$660	\$795
700 x 700mm	\$560	\$720	\$855
600 x 800mm	\$580	\$745	\$880
800 x 800mm	\$630	\$800	\$935
1000 x 1000mm	\$800	\$1000	\$1135

- **Frames:** 150mm deep extruded aluminium frame, double-sided, powder coated in black
- **Face:** 3mm/4.5mm thick opal acrylic panels on both sides
- **Light source:** Side-lighting LEDs
- Waterproof and UV resistant, indoor and outdoor use
- Flush mount on the wall or with additional wall brackets



WB-160



LB-DS-S



LB-DS-L

LB-DS Size	Hardware Only	With Printing	With Bracket
500 x 400mm	\$460	\$610	\$745
800 x 400mm	\$500	\$680	\$815
1000 x 400mm	\$550	\$760	\$895
1200 x 400mm	\$575	\$800	\$935
1500 x 400mm	\$700	\$970	\$1105
1800 x 400mm	\$800	\$1100	\$1235
2000 x 400mm	\$960	\$1290	\$1425
2200 x 400mm	\$1015	\$1390	\$1525
2200 x 500mm	\$1060	\$1435	\$1575
2400 x 400mm	\$1120	\$1505	\$1640
2400 x 500mm	\$1160	\$1550	\$1685
2400 x 600mm	\$1210	\$1600	\$1735

- **Frame:** 150mm deep extruded aluminium frame. Powder coated in black
- **Face:** 3mm/4.5mm thick opal acrylic panels on both sides
- **Light source:** Bright white side-lighting LED modules, bright and even illumination
- Waterproof and UV resistant, indoor and outdoor use

Aluminium fabricated frame with black powder coating (customized colour at extra cost)
150mm depth box frame | LED lighting source | 3mm/4.5mm opal acrylic face panel | Hanging bracket 1.2m at \$135/ pair.

Round Light Box

Single-Sided Aluminum Light Box LB-RD-FLAT-S



Size	Hardware Only	With Printing
500mmD	\$430	\$510
600mmD	\$460	\$570
700mmD	\$530	\$640
800mmD	\$620	\$750
1000mmD	\$875	\$1040
1200mmD	\$1380	\$1520

- **Frames:** Extruded aluminium with black powder coating
- **Face:** 3mm/4.5mm thick flat opal acrylic face
- **Light source:** Side-lighting LEDs, cool white
- Exterior and interior use
- Comes with wall mounting angle bracket ready to be fitted on to wall, plug and play

Round Light Box

Double-Sided Aluminum Blade Sign | Single Post LB-RD-SP



Size	Hardware Only	With Printing
500mmD	\$525	\$675
600mmD	\$575	\$740
700mmD	\$630	\$815
800mmD	\$720	\$925
1000mmD	\$990	\$1165

- **Frames:** Extruded aluminium with black powder coating
- **Face:** 3mm/4.5mm thick flat opal acrylic face, double-sided
- **Light source:** Side-lighting LEDs, cool white
- Exterior and interior use
- Come with single post ready to be fitted on to wall or ceiling, plug and play

Double-Sided Aluminum Blade Sign – Vacuum Formed Face LB-RV



Size	Hardware Only	With Printing
500mmD	\$550	\$650
600mmD	\$560	\$710
700mmD	\$575	\$750
800mmD	\$630	\$840

- **Frames:** Extruded aluminium with black powder coating
- **Face:** 3mm thick vacuum foamed opal acrylic face, double-sided
- **Light source:** Side-lighting LEDs, cool white
- Exterior and interior use
- Comes with brackets ready to be fitted on to wall or ceiling, plug and play

Double-Sided Aluminum Blade Sign | Circle Light Box LB-RD-FLAT



Size	Hardware Only	With Printing
500mmD	\$540	\$690
600mmD	\$575	\$740
700mmD	\$630	\$815
800mmD	\$720	\$925
1000mmD	\$990	\$1165
1200mmD	\$1400	\$1630

- **Frames:** Extruded aluminium with black powder coating
- **Face:** 3mm/4.5mm thick flat opal acrylic
- **Light source:** Side-lighting LEDs, cool white
- Exterior and interior use
- Come with brackets ready to be fitted on to wall or ceiling, plug and play

Acrylic Light Box

Acrylic Fabricated LED Circle Light Box LACYLB-R

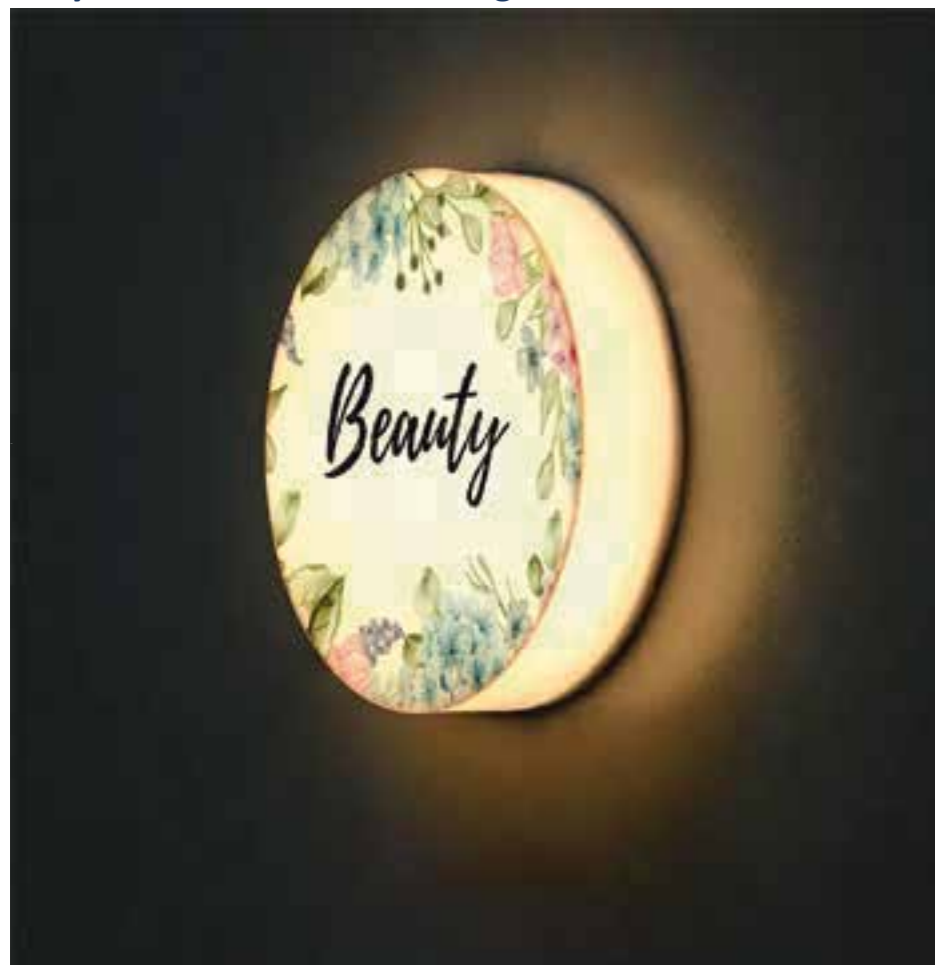

Size	Hardware Only	With Printing
500mmD	\$595	\$655
600mmD	\$650	\$720
700mmD	\$710	\$790
800mmD	\$780	\$870
1000mmD	\$930	\$1040
1200mmD	\$1100	\$1220

- Opal acrylic fabricated light box (3mm, 4.5mm acrylic panel as per demand)
- LED modules 12V/240V, 6500K fixed on back panel (Optional 3000k, 6500k & 10000k)
- Colour LED available with optional full colour printed graphic or cut out vinyl graphic applied on surface (extra cost)
- Bright and Even Illumination (Face and Side)
- Exterior and interior use
- Standard thickness (return): 100mm

Luminated Lollipop Signs Lollipop Sign



- **Size:** 340mm in diameter double side printed light box
- **Approx Weight:** 700gms including the monopole and battery
- **Frame Colours:** Aluminum/silver
- **Monopole:** 60cm standard

Lollipop Sign	Price
1 Unit	\$490
2 Units	\$590
3 Units	\$790
4 Units	\$990

Acrylic Light Box

Acrylic Fabricated LED Cube Light Boxes ACYLB-SQ



Size	Hardware Only	With Printing
500 x 300 x 300mm	\$595	\$695
500 x 500 x 500mm	\$795	\$945
600 x 600 x 600mm	\$895	\$1045
700 x 700 x 700mm	\$1045	\$1195
800 x 200 x 200mm	\$745	\$945
1000 x 300 x 300mm	\$945	\$1145
1200 x 300 x 300mm	\$1045	\$1265
1500 x 300 x 300mm	\$1295	\$1535

- Opal acrylic fabricated light box (3mm 4.5mm 6mm acrylic panel as per demand)
- LED modules 12V/240V, 6500K fixed on back panel (Optional 3000k, 6500k & 10000k)
- Colour LED available (extra cost)
- Full colour print graphic or cut out vinyl graphic applied on surface
- 5 sides illumination
- Exterior and interior use

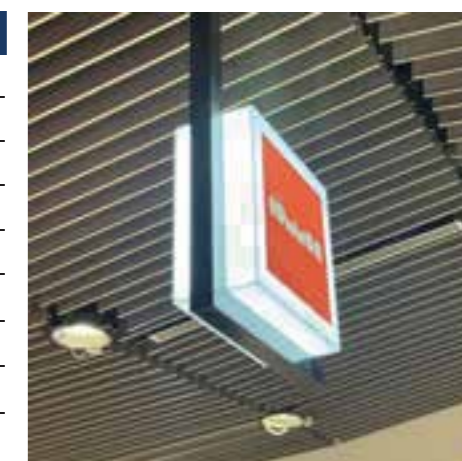

LED Window Signs



Real Estate Window Display LED Lightbox A3 Size | LED Window Signs

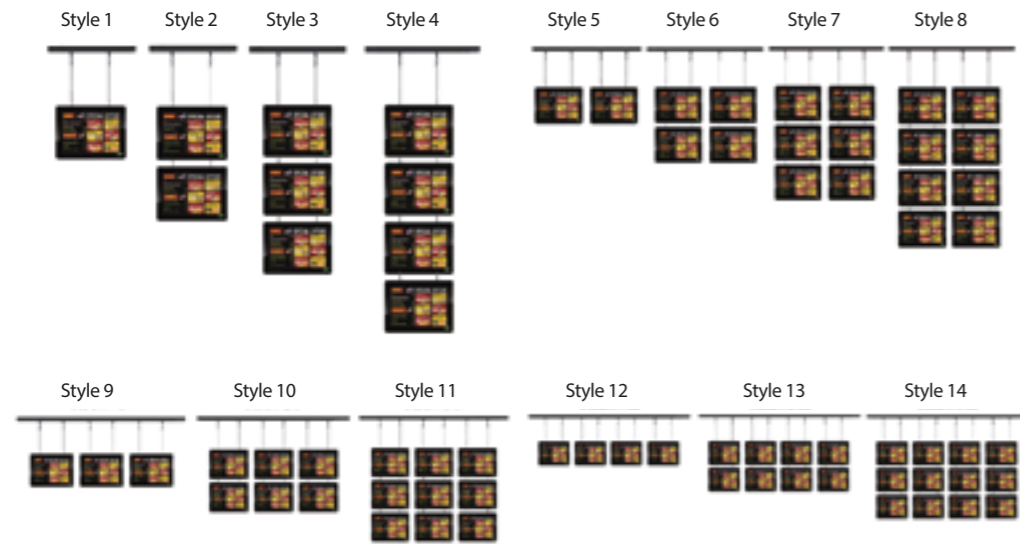

Style	Price
Style 1	\$210
Style 2	\$345
Style 3	\$465
Style 4	\$600
Style 5	\$375
Style 6	\$590
Style 7	\$880
Style 8	\$1145
Style 9	\$580
Style 10	\$980
Style 11	\$1400
Style 12	\$765
Style 13	\$1310
Style 14	\$1850

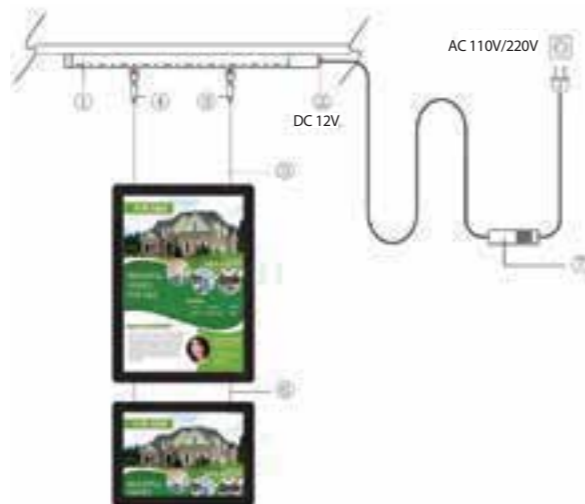

- Package Includes:**
1. Ceiling Rail Tack
 2. DC Plug
 3. Positive Standoff
 4. Negative Standoff
 5. Ceiling Stainless Steel Cables
 6. 45mm Mini Joiners
 7. Transformer

LED Window Signs



Real Estate Window Display LED Lightbox A4 Size | LED Window Signs

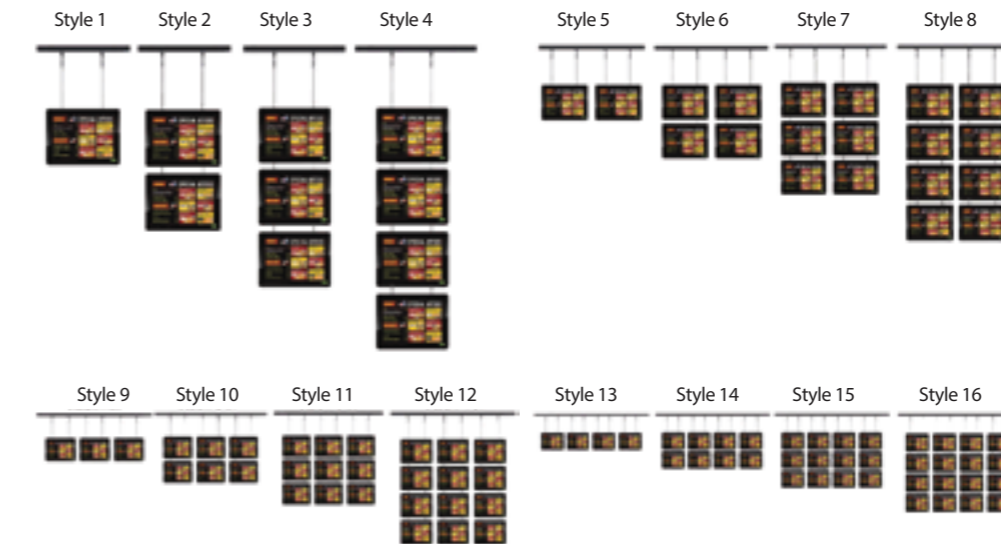

Style	Price
Style 1	\$200
Style 2	\$295
Style 3	\$395
Style 4	\$485
Style 5	\$315
Style 6	\$525
Style 7	\$700
Style 8	\$895
Style 9	\$495
Style 10	\$775
Style 11	\$1080
Style 12	\$1350
Style 13	\$590
Style 14	\$980
Style 15	\$1395
Style 16	\$1795

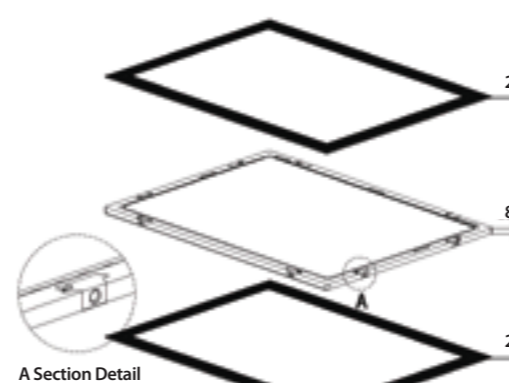

- Package Includes:**
1. Ceiling Rail Tack
 2. DC Plug
 3. Positive Standoff
 4. Negative Standoff
 5. Ceiling Stainless Steel Cables
 6. 45mm Mini Joiners
 7. Transformer

Flexface Vinyl Banner Light Box



OFLB-01-2

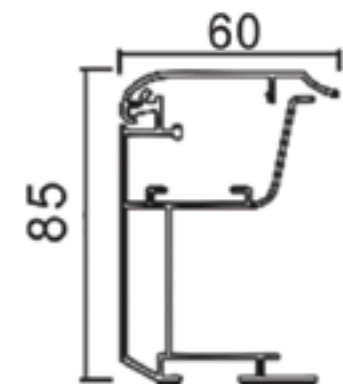
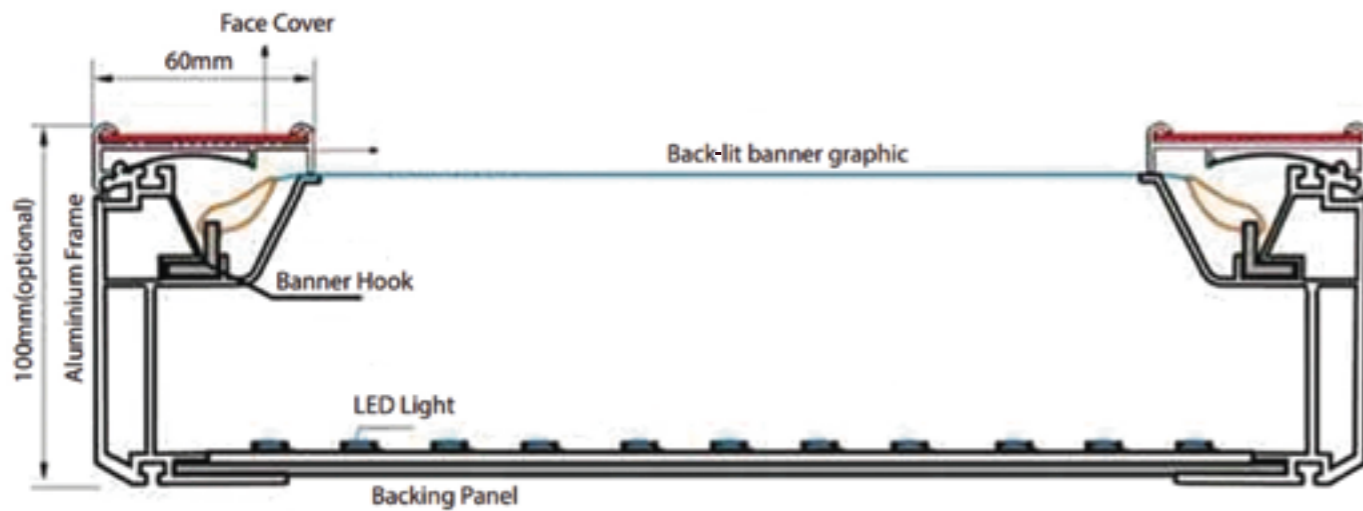

- Aluminum Frame LED light box, known as flex face light box, suitable for outdoor back-lit vinyl banner, can be assembled easily in house or on site for installation
- Minimum package size compare to traditional light box. Cost effective and easy to handle
- Great choice for large scale light boxes over 3 meters

Size	Price
800 x 4000 x 85mmD	\$2250
1300 x 3500 x 85mmD	\$2580
1500 x 3000 x 85mmD	\$2650
2000 x 4000 x 85mmD	\$4450

Advertising LED Logo Projector

Premium Outdoor Large Industrial Waterproof LED Projector LOPRO-L



Wattage Rating Option	Price
300W	\$1650
600W	\$2250
1200W	\$4680

Projection Distance: (dark environment)
 300W projector: within 30 meters
 600W projector: within 50 meters
 1200W projector: within 100 meters

Advertising LED Logo Projector LOPRO



15W/35W LED Projector 50W LED Projector-outdoor use (water proof)



Wattage Rating Option	Price
15W	\$380
35W	\$450
50W Indoor Use	\$550
50W Outdoor Use Water Proof	\$600
80W Outdoor Use Water Proof	\$750
100W Outdoor Use Water Proof	\$900
200W Outdoor Use Water Proof	\$1350

Advertising LED Logo Projector 7 Rotating Logos	
60W-600W	\$850-\$2250

- Choose to project 1, 4 or 7 images, logos or text onto the ground, walls or other surfaces
- Includes mounting bracket for easy wall or ceiling installation

Projection Distance (dark environment):

- 15W projector: within 3 meters
- 35W projector: within 5 meters
- 50W projector: within 8 meters
- 80W projector: within 10 meters
- 100W projector: within 12 meters
- 200W projector: within 20 meters

* >50W is suitable for interior daytime use
 * Choose higher wattages for brighter environments

Fabric Light Box

Free-Standing Double-sided LED Light Box FLB-01F



Size	Depth	Single Side Print	Double Side Print
850 x 2000mmH	80mmD	\$800	\$900
1000 x 2000mmH	80mmD	\$850	\$950
1000 x 2400mmH	80mmD	\$1060	\$1250
1200 x 2400mmH	120mmD	\$1295	\$1495
2000 x 2400mmH	120mmD	\$1890	\$2150
2400 x 2400mmH	120mmD	\$2190	\$2580
3000 x 2400mmH	120mmD	\$2550	\$1980
4000 x 2400mmH	120mmD	\$3350	\$3790

The listed prices do not include carry bag. Carry bag costs \$120+gst each.

- Made of aluminum frame, Led strips, silicone seal
- Fast installation and dismantle, professional UV printing
- Premium grade backlit-fabric material
- Easily replaceable graphics
- Base size: 380x80mm
- High end green product, reusable for many times
- Suitable for all kinds of shopping mall and other advertisement use

Single Side Fabric Light Box | Large Round Light Box FLB-R-SS



Size	Price
800mm	\$650
900mm	\$650
1000mm	\$750
1200mm	\$950
1500mm	\$1250
1800mm	\$1750
2000mm	\$1950
2400mm	\$2480
3000mm	\$3550

Graphics printed for the frameless light box provide a rich, vibrant colour quality that is second to none.

- **Smooth Edge-less Appearance**
The edge-less (frameless) look is achieved by using fabric which is sewn along the edges with a silicone beading. The graphic is stretched slightly over the extrusion where the silicon beading fits into a channel groove along the outer edge of the display.
- **Portable**
Frameless light boxes are made from lightweight recycled aluminium. It is very easy to dismantle and can be done in just a few minutes, which makes it great for trade shows, events or relocating. Despite their large display size, they can be stored in very small spaces.

Fabric Light Box

Fabric Light Box FLB-01



Size	Depth	Price
800 x 2400mm	80mmD	\$950
850 x 2000mm	80mmD	\$850
900 x 1200mm	80mmD	\$650
1000 x 3000mm	80mmD	\$1500
2000 x 2000mm	80mmD	\$1650
2000 x 3000mm	80mmD	\$2400
2000 x 4000mm	80mmD	\$3600
2300 x 6000mm	80mmD	\$4800



- Graphics printed for the frameless light box provide a rich & vibrant color quality that is second to none.
- The frameless light box is made from lightweight recycled aluminium. It is very easy to dismantle and can be done in just a few minutes, which makes it great for trade shows, events or relocating. Despite their large display size, they can be stored in very small spaces.

A4 LED Counter Top Banner Stand LBA4-Counter Top



- Compact travel display size
- Double Sided
- Built-in battery, it can be charged by the power bank via USB port, convenient to use
- Lithium battery, 5V, 2A, 5W Capacity: 10,000mah

Print Options	Price
Non Printed	\$90
Single Sided Printing	\$125
Double Sided Printing	\$135
Print Only_4pcs	\$80

Outdoor LED A-Frame with Magnetic Light Box A6090-LED



- Durable, portable and user friendly
- Powder coated black frame to keep rust free
- Easy change of graphics
- Clear acrylic panel with strong magnet front panel holder
- Even light dispersion. Luminance emitted is 2000lux +/-5%. Provide best-illuminated outcome for your poster
- Low maintenance cost



Price From \$295

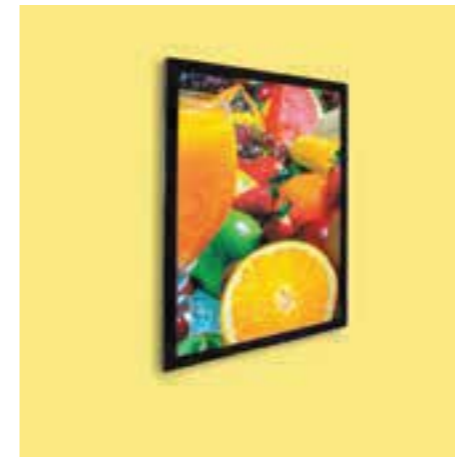

MLB-22

22.8mm Magnetic Light Box

- Open with suction cup
- Quality LED light source
- **Thickness:** 22.8mm
- Acrylic face front attached to aluminium frame with magnet
- **Colour:** silver or black
- **Available sizes:** A0, A1, A2, A3 (Customized sizes available)

Size	Price
A3	\$195
A2	\$265
A1	\$375
A0	\$650

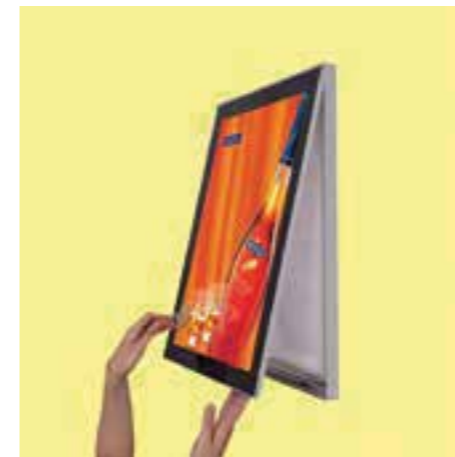

LB-M-A2

Ultra Slim Magnetic Light Box

- Quality LED light source
- **Thickness:** 10mm
- Acrylic face front attached to aluminium frame with magnet
- **Colour:** silver or black
- **Available sizes:** A1, A2, A3 (Customized sizes available)

Size	Price
A3	\$139
A2	\$175
A1	\$285



MLB-10

Ultra Slim Magnetic Light Box

- Quality LED light source
- **Thickness:** 10mm
- Acrylic face front attached to aluminium frame with magnet
- **Colour:** Silver/Black (Custom colours is doable : gold , red, white, etc)
- **Available sizes:** A0,A1, A2, A3 (Customized sizes available)

Size	Price
A3	\$139
A2	\$175
A1	\$285
A0	\$515



LB-OD

Outdoor Light Box With Locker

- Quality LED source
- Outdoor use
- Hinged swing door with lock
- Genuine SAA approved power adapter
- Portait & Landscape display (Customized sizes available)

Size	Price
A1	\$595
A0	\$950

LCD Menu Board



Commercial Advertising LCD Device

Specifications: 43 inch

- **Screen**
 Full Size: 1006x601xmm
 Display Size: 939x527mm
 LCD Manufacturer: Samsung/LG/BOE
 Resolution: 1920x1080
 Aspect Ratio: 16 : 9
 Brightness(nits): 500
 Contrast Ratio: 6000 : 1
 Viewing Angle: 178 / 178
 Life Span: 65000 hours
 Certificate: CE, FCC
- **Control System**
 System: Android 9.0 + Cloud Based Remote Control system
 CPU: RK3288
 RAM: 2G
 ROM: 16G
 HDMI Port: 1
 WIFI Antena: Yes
 3G/4G Mobile Network: Yes(Optional)
 RJ45 Ethernet Port: 10M/100M
 USB: 2
 Video Format: wmv,avi,flv,rm,rmbv,mpeg,mp4,etc.
 Speaker: Yes



- **Environment**
 Power Input: AC 110-240V
 Power Consumption: 45W
 Operation Environment: Indoor
 Operation Temperature: 0°C-40°C
 Operation Humidity: 20% ~ 80%
 Screen Surface: Tempered Glass
 Enclosure Material: Steel



LED Scrolling Signs



LED-CP8



LED-C5



LED-C5

10mm/5mm PITCH Full Colour LED Sign

Display Area	Frame Size	5mm Pitch	10mm Pitch
960 x 320mm	1010 x 370mm	\$1200	\$1080
960 x 480mm	1010 x 530mm	\$1800	\$1620
960 x 640mm	1010 x 690mm	\$2250	\$2160
1280 x 320mm	1330 x 370mm	\$1500	\$1440
1280 x 480mm	1330 x 530mm	\$2300	\$2160
1280 x 640mm	1330 x 690mm	\$2800	\$2680
1280 x 800mm	1330 x 850mm	\$3400	-
1600 x 320mm	1650 x 370mm	\$1850	\$1800
1600 x 480mm	1650 x 530mm	\$2700	\$2650
1600 x 640mm	1650 x 690mm	\$3400	\$2950
1920 x 320mm	1970 x 370mm	\$2150	\$1950
1920 x 480mm	1970 x 530mm	\$3050	\$2650
2240 x 320mm	2290 x 370mm	\$2550	\$2250
2240 x 480mm	2290 x 530mm	\$3750	-
2560 x 480mm	2610 x 530mm	-	\$3400

Price of the LED modules may change, please contact for updated prices

- Customized size available
- Perfect for displaying videos, supporting most popular file formats, including AVI, WMV, RMVB, MOV, MP4, MPG, FLV, SWF, VOB, etc.
- Eye catching solution for advertising
- Suitable for both indoor and outdoor use
- Can be programmed easily by mobile or computer through WIFI
- High brightness adjustable



Sign Accessories



Equipment & Tools



Sign Accessories



SSC16



MG-EYE



LED-SL



BWD-150

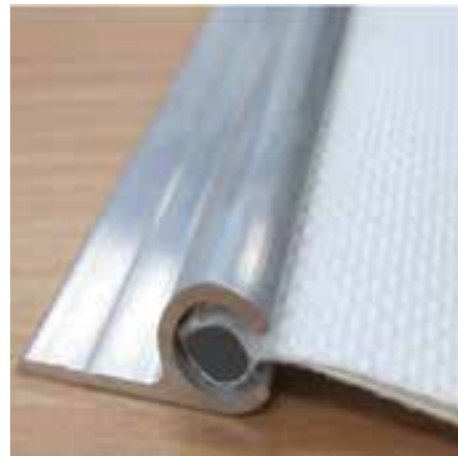

KDE75

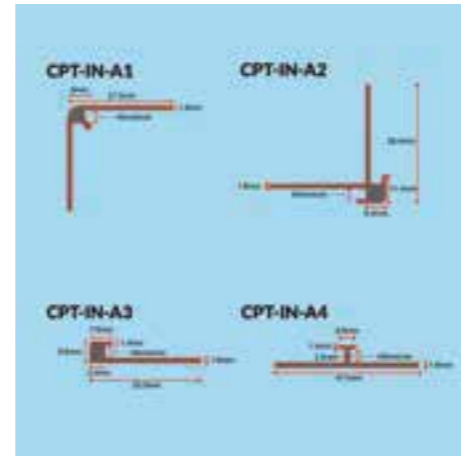

PT-V



LB-Wall Bracket



LB-Hanging Bar



ALU-POLE

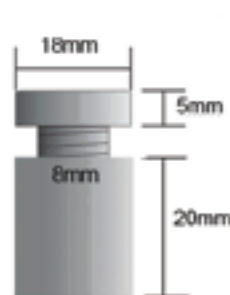

SPS1820

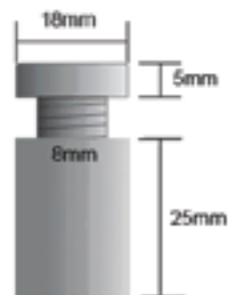

SPS1825

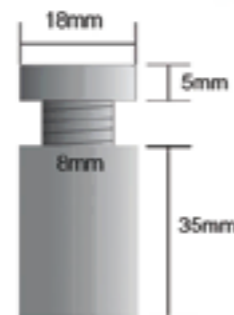

SPS1835

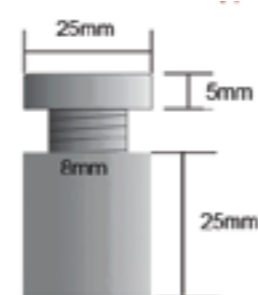

SPS2525

Sign Accessories

Product Code	Product	Size	QTY	Price
SSC16	Screw Cover	16mm	40pcs	\$39
SSC19	Screw Cover	19mm	40pcs	\$49
SSC25	Screw Cover	25mm	40pcs	\$59
MG-EYE	Grommets & Eyelets	6mmD-12mmD	500pairs	\$50-100
LED-SL	Solar Powered Flood Light – 15W	-	1unit	\$385
BWD-150	Bubble Wrap Rolls Dispenser	1500mm	1unit	\$359
KDE75	Kedar Edging Sail Track Aluminium Rope Track	7.5mm	1unit	\$40
PT-V	Panel Trims and Joiners for Aluminum Sheets	-	1unit	\$45
LB-Wall Bracket	Light Box Wall Brackets	160mm	1pair	\$135
LB-Hanging Bar	Light Box Hanging Bar	1200mm	1pair	\$135
ALU-POLE	Aluminum Pole Auction Flag Pole Open Banner Rod	1620x25mm	1unit	\$25
SPS1820	Panel Mounts	18 x 20mm	6pcs	\$35
SPS1825	Panel Mounts	18 x 25mm	6pcs	\$35
SPS1835	Panel Mounts	18 x 35mm	6pcs	\$39
SPS2525	Panel Mounts	25 x 25mm	6pcs	\$39



DST-4910

3M VHB 4910 Double-sided Tape | Clear Acrylic Tape 1.0mm Thick | Super Sticky

3M VHB 4910 is a 1.0mm thick transparent acrylic adhesive, with strong adhesive force, professional for the long-lasting adhesion of transparent materials such as glass, organic glass, acrylic, etc., waterproof and high temperature, short-term high temperature resistance 149 °C, long-term high temperature resistance 93 °C, no residue.

Thickness /Length/ Width	Price
1.0mm/33M/10mm	\$45
1.0mm/33M/12mm	\$50
1.0mm/33M/15mm	\$60
1.0mm/33M/20mm	\$70
1.0mm/33M/25mm	\$80



3MVHB4941/4950/5952

3M Grey/White/Black Acrylic Foam Tape Double Side Adhesive

1.14mm thick Grey/White/Black closed structure Acrylic foam, high-strength bonded metal, glass, plastic, short-term high temperature 149°C, long-term high temperature resistance 93°C, high tensile force and shear strength and can be used to replace traditional fixation methods such as screws, wilow nails, and spot welding,

Thickness /Length/ Width	Price
1.14mm/33M/10mm	\$40
1.14mm/33M/12mm	\$45
1.14mm/33M/15mm	\$55



DST-9080

3M 9080 Double Sided Tape | Strong Adhesive 0.16mm Thick | Super Sticky 50M

- Heat-Resistant
- Strong adhesive
- Strong tensile strength
- Suitable for irregular surface because of flexibility
- High level of initial tack and good adhesion to a wide variety of surfaces

Thickness /Length/ Width	Price
0.16mm/50M/15mm	\$25

Buy in Bulk, please contact us for wholesale price

Laminating Machine

1.3M(51")/1.6M (63") Manual Wide Format Roll Cold Laminating Machine



Bracket with Reinforced Design



High Quality Rubber Roller



Rubber Roller Height Adjustment



Manual Lamination



LM-M01

- **Max.working width** 1300mm/1600mm
- **Max.substrate thickness** 20mm
- **Pastern roller lift height** ≤20 mm
- **Application** Indoor/outdoor AD and photograph laminating
- **Gross Weight** 65/72KG
- **Packing Size** 1500x380x430mm/1800x380x430mm

Working Width	Price
1300mm	\$900
1600mm	\$1100

1.6M (63")Premium Manual Wide Format Roll Cold Laminating Machine



LM-M03



- **Max.working width** 1600mm
- **Max.substrate thickness** 20mm
- **Pastern roller lift height** ≤20 mm
- **Application** Indoor/outdoor AD and photograph laminating
- **Gross Weight** 90KG
- **Packing Size** 1930mm x 520mm x430mm

Working Width	Price
1600mm	\$1600

Laminating Machine

1.6M (63") Electrical Wide Format Roll Cold -Laminator, Laminating Machine



LM-M02

- **Max. Laminating width** 1600mm
- **Max. Laminating thickness** 20mm
- **Speed range** 0-7000mm/min
- **Power Supply** AC110, 220V/50, 60Hz
- **Power** 50W
- **Dimensions(LxWxH)** 180x40x40cm
- **Weight** 110kg
- **Application** Indoor/outdoor AD and photograph laminating

Working Width	Price
1600mm	\$1600

1.63M (64") 1700F5 Semi-auto Warm Laminating Machine – LAMINTING & CUTTING

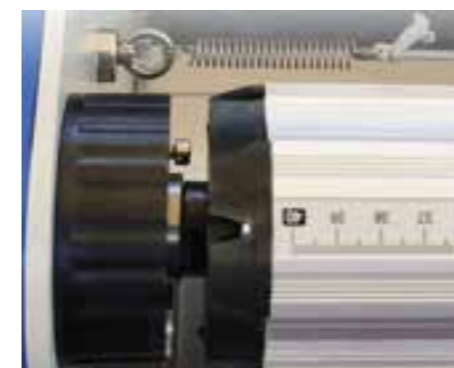

LM1700-F5

- **Max.working width** 1630mm/64"
- **Max lamination thickness** 23mm/0.9"
- **Max speed** 6m/min
- **Max temp** 60°C/140°F
- **Up and down** Hand Crank
- **Heating** Infrared
- **Warm up time** 5-10 min
- **Power consumption** 0.5-0.8kw/h
- **Power input** 1400W
- **Volt** 110V/220V
- **Net Weight** 150KG

Working Width	Price
1630mm	\$5900

Laser Engrave Machine | WMY-2513 Flatbed Laser

The WMY-2513 is a VOLASER for professional large-scale cutting. You can cut many non-metal materials, such as MDF, Acrylic, Bamboo, Cloth, Plastic, and more. Leather, High-power tubes are not suitable for engraving



WMY-2513

● Features

- 3rd generation high-speed CO² laser
- Long-life tube (>10000 hours)
- Imported Lenses and mirrors
- High quality belts
- High-precision stepper motors
- Precision X-Y-Z-Axis control
- 2mm steel used in body construction
- Low maintenance, high reliability
- Quiet and clean cutting
- Shipped to you as a completely pre-assembled and factory-tested system

● Advantages

- Cuts a wide range of materials and thicknesses
- No tool changes reduce job setup time
- Produces a high-quality cut reducing secondary finishing operations and associated costs
- Low electrical consumption
- Perfect for short-run or just-in-time production

MW Transformer



MW-320

● Features

- Constant Voltage + Constant Current mode output
- Metal housing with class I design
- Built-in active PFC function
- IP67/IP65 rating for indoor or outdoor installations
- **Function options:** output adjustable via potentiometer; 3 in 1 dimming
- Typical lifespan > 62,000 hours

Product Code	Capacity	Price
MW-75	75W	\$70
MW-150	150W	\$90
MW-240	240W	\$120
MW-320	320W	\$180

Sliding 1800mm Corflute Board Cutting Ruler, Large Format Trimming Ruler

- **Length:** 1800mm/2600mm
- **Material:** Industrial aluminum alloy, strong and durable
- **Cutting thickness:** up to 10mm
- **Applicable materials:** PP Paper, Thin PVC, Foam Board, Corflute Panel, PET Film, Vehicle Wrap, Adhesives, Photo Paper or other rolled materials

1800mm

\$315

2600mm

\$550

Large Format Trimming Ruler | Aluminum Extrusion Trimmer C

- **Size:** 1800mm/2600mm
- **Cutting thickness:** up to 10mm
- **Ideal for cutting:** digital prints, vinyl, films, paper & cardboard
- Optional extended squaring arm for improved accuracy

Size	No Stand	With Stand
1800mm	\$1200	\$1550
2600mm	\$1650	\$1950



TIMEER-C

Eyelets Puncher Machine/ Grommet Alloy Ring Punch Press Machine

- Manual grommet machine
- Made in cast iron, painted
- Comes with 500 pairs eyelets (hole diameter: 10mm) and 10mm die/head which will fit 10mm eyelets only
- **Options for additional die:** 6mm/8mm/10mm/12mm
- **Packing size:** 40x30x20cm
- **Weight:** 4kg

Price

\$245

Size	Eyelets	Die
6mm Copper	\$55	\$50
8mm Silver	\$55	\$50
10mm Copper/Silver	\$60	\$50
12mm Copper/Silver	\$65	\$70
10mm Stainless Steel	\$80	-
12mm Stainless Steel	\$100	-



MG-MA



MG-SA

Eyelets Puncher Machine/Semi-automatic Grommet Machine

- Ideal for craft and industrial use; Applicable for banners, signs, awnings, posters, curtains, digital printing, clothing, bags, shoes and more
- Simple structure and high efficiency, convenient and easy to use
- Automatic grommet feeding and will not buckle
- 1000pcs of eyelets included (10mm)

Price

\$335

4-Worktable Pneumatic /Hydraulic Heat Press Machine

- **Control panel:** intelligent instrument and digital display of temperature and time, the readout temperature tolerance of which is $\pm 2^\circ$
- **Pneumatic device:** with electric rotation automatic control, high printing speed, high accurate performance, its pressure can be 8kg/cm²
- **Operation mode:** it adopts automatic motor rotation, saving time and labor, and it's convenient for operation
- **Movable heating plate:** the upper plate is movable and the lower plate is fixed which ensure the garment stays well
- **Silicone pad:** the silicone pad can endure high temperature even reach 390°C and will not change the shape
- **Voltage:** 240V
- **Power:** 2800W

Pneumatic

\$9900

Hydraulic

\$11500



HEATPRESS-4S

Double-sided, Self-healing Cutting Mat

- **Material:** PVC
- **Thickness:** 3mm

Size	Price
900 x 1200mm (Roll Pack)	\$99
900 x 1200mm (Flat Pack)	\$135
1200 x 2400mm (Roll Pack)	\$300



CM-01

Exhibition & Event



Prize Wheel



Wheel-01

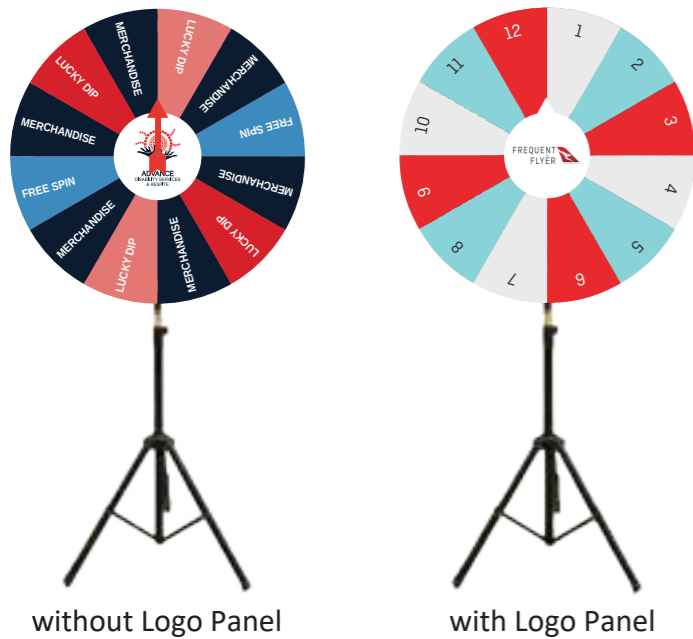

Big Prize Wheel, Lucky Spin, Roulette Wheel

- It is great for trade shows, promotional events, bars and restaurants, retail settings and many other purposes
- Popular used in retail shops for a lucky spin, win gift/ \$\$/ discount for next shopping
- Fun activities for corporate affairs, sales meetings and school activities
- Kid's Lands lucky draws for fun rewards
- Fully custom design printed: Download the artwork template and design whatever you like
- Panel made of 3mm Aluminum Composite Metal
- Size options: 1000mm / 1200mm
- Height Adjustable: 1540mmH-2450mmH / 1740mmH-2550mmH

Product Code	Size	without Logo Panel	with Logo Panel	Add Gloss Lamination
Wheel-01	1000mmD	\$360*	\$395*	\$455*
Wheel-01	1200mmD	\$460*	\$495*	\$555*

Other Options

- Arrow with colour painted/colour vinyl @\$60+GST additional

Prize Wheel



Wheel-02



Tabletop Fortune Carnival Prize Wheel, Lucky Spin, Roulette Wheel

- This Counter Top Prize Wheel offers customizable prize segments: you can write on or buy printed surface with branded logo
- It features a dry erase surface for customizing the prize slot sections easily
- It is great for trade shows, promotional events, bars and restaurants, retail settings and many other purposes
- It is perfect for fun activities, trade shows, corporate affairs, carnivals, annual meetings, parties, school activities, etc.
- The "Clicking" sound made as wheel spins adds excitement and draws in crowds
- Option of custom design printed: Download the artwork template and design whatever you like.
- Panel made of 10mm hard PVC & acrylic board

Product Code	Size	Logo Print	Custom Prize with Logo Print
Wheel-02	15"/380mmD	\$185*	\$225*
Wheel-02	24"/600mmD	\$229*	\$295*

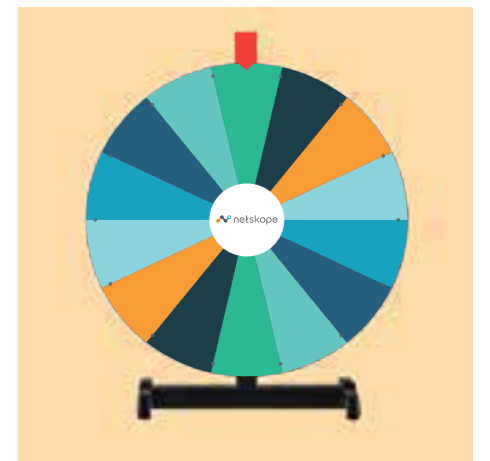

Run-Through Banner



RUN-B

Football Sporting Run-Through Banner

Our Run-Through banner is NOT made of crepe paper. It is printed on easy-break-up paper stock, or 510gsm vinyl banner or fabric banner with pre-cut lines. Full colour printing

- Include pockets on two sides: 100mm (for 60mm diameter pole)
- Include top pocket 50mm (for 30mm diameter pole/wood rod)
- Not include poles for easy pack up and delivery (you can easily purchase from your local Bunnings Warehouse)



Options	2500 x 1800mm	4000 x 2500mm	5000 x 3000mm	5000 x 3500mm
Single Side	\$450	\$650	\$950	\$1300
With 4 Replacement Numbers	\$650	\$850	\$1150	\$1500
With 2 PVC Clear Pockets	\$530	\$730	\$1030	\$1380
Double Sides	\$600	\$1000	\$1600	\$2180
With 4 Replacement Numbers	\$650	\$1360	\$1960	\$2540
With 2 PVC Clear Pockets	\$530	\$1150	\$1750	\$2300

Arch Banner

Arch Banner | Car Promo Banner

- This Arch Banner is perfect for indoor or outdoor use. Hold this banner by hands in a event will make your message standing out in the crowd

- **Material**
Full colour dye sublimation print on 115gsm Mesh Fabric
- **Warranty**
2-Year on hardware
- **Package**
1x printed banner, 1x set fiberglass pole with carry bag, 2 of bases as per choic



FLB-Car ARCH

Sports Outdoor Event Run-Through Arch Banner

- Sponsors love Run-Through Banner. It provides an opportunity for them to promote themselves in a way that is guaranteed to have crowd's focus
- Run-Through banners are perfect for keeping your existing sponsors happy and are very powerful and effective tools to help bring new sponsors on board
- Made of 250gsm knitted fabric material with single side dye-sub printing
- Come with pre-cut lines (strips) to allow easy run through for photo taking
- Portable and reusable



RUN-ARCH

Arch Banner | Arch Flag Sport Sign

Arch Banner is a great choice for outdoor sport event or fun activities

- **Material**
Full colour dye sublimation print on 110gsm knitted polyester
- **Warranty**
2-Year on hardware
- **Package**
Printed Banner, Fiberglass Pole, Spike Base, Carry Bag



FLB-ARCH

Product Code	Size	Single Side	Double Side
FLB-Car ARCH	2650 x 2500mm	\$325	\$415
RUN-ARCH	5500 x 3000mm	\$900	\$1680
FLB-ARCH	6000 x 4000mm	\$750	\$950



Promotional Tables



PT-SEG



PT-01



PT-03



PT-03-XL

Product Code	Size	Price
PT-SEG	1000 x 1000mmH x 400mmW	\$700
PT-01	1280 x 975mmH x 460mmD	\$375
PT-03	1230 x 965 mmH x 650mmD	\$595
PT-03-XL	2200 x 965mmH x 950mmD	\$1580
PC-1	870 x 890mmH x 450mmD	\$380

Please check updated price on web page

Promotional Tables



PT-EZY-L



PT-09



PT-EZY



PT-EZY-T

Product Code	Size	Price
PT-EZY	915 x 930mmH x 455mmD	\$325
PT-EZYH	915 x 930mmH x 455mmD	\$380
PT-EZY-L	1200 x 930mmH x 500mmD	\$480
PT-EZY-T	1195 x 940mmH x 505mmD	\$385
PT-09	400 x 900mmH x 400mmD	\$345



PC-1



PT-EZYH

Promotional Tables



PT-10



PTL-S



PT-07



PT-08

Product Code	Size	Price
PT-10-160	1600 x 965mmH x 520mmD	\$850
PT-10-200	2000 x 965mmH x 520mmD	\$1250
PT-10-300	3000 x 965mmH x 520mmD	\$1850
PTL-S	800 x 980mmH x 400mmD	\$600
PT-07	1600 x 900mmH x 520mmD	\$850
PT-08	700 x 970mmH x 400mmW	\$419
Table-03	1829 x 737mmH x 762mmW	\$750
Table-03	2438 x 737mmH x 762mmW	\$850



Table-03

Media Walls



Media-W04



Customised Party Wall | Birthday Backdrop

Transform your event, birthday, or wedding into an unforgettable experience with our foam board backdrops! Our Party media wall is an eye-catching choice. This foam board media wall comes in a range of traditional sizes, but with our new custom size option, you can create a photography media wall that is perfectly sized to fit your display space

Style	5mm Board	10mm Board
Style 1	\$185	\$275
Style 2	\$350	\$550
Style 3	\$400	\$560
Style 4	\$450	\$580
Style 5	\$480	\$750
Style 6	\$520	\$620
Style 7	\$680	\$880

Media Walls



Media-W03



Media-W03 Size	Price
1500 x 2000mmH	\$360
2000 x 2000mmH	\$430
2400 x 2300mmH	\$550
3000 x 2300mmH	\$650



Media-W02



Media-W02 Size	Price
2440 x 2440mmH	\$900
3660 x 2440mmH	\$1200
4880 x 2440mmH	\$1600
9700 x 2400mmH	\$2400



Media-W01



W01-B \$80

Media-W01 Size	Price
2440 x 2440mmH	\$480
3000 x 2440mmH	\$750
3660 x 2440mmH	\$880
4880 x 2400mmH	\$990

Media Walls



POP-PVC-C



POP-PVC-S



Spot lights

POP-PVC Size	No Hardcase Top	1xHardcase Top	2xStandard Pull Up Banner	2xLuxury Pull Up Banner
3 x 3m Curve	\$1700	\$1780	\$1960	\$2110
3 x 3m Straight	\$1700	\$1780	\$1960	\$2110
3 x 4m Curve	\$1800	\$1880	\$2060	\$2210
3 x 4m Straight	\$1900	\$1980	\$2160	\$2310



POP-12

POP-12 Size	Price
2250 x 2250mmH	\$850
3000 x 2250mmH	\$1050



POP-2

POP-2 Size	Price
2250 x 2250mmH x 300mmD	\$850
3000 x 2250mmH x 300mmD	\$1050

Pop Up Stand

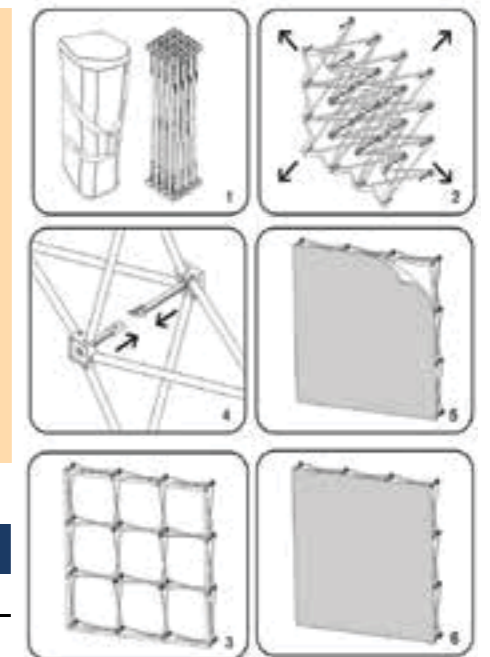



WB-S



WB-S Size	Price
3m x 3mH x 0.3mD	\$1950
6m x 3mH x 0.4mD	\$3150
9m x 3mH x 0.4mD	\$4150
6m x 4mH x 0.5mD	\$3750
9m x 4mH x 0.5mD	\$4950

Premium Fabric Wrapped Wall Box

This is a super Luxury Fabric made Wall. 30-40cm depth makes it suitable for both indoor and outdoor events. This stylish Wall banner is commonly used by Luxury Brands as it brings most of attention of guests in the events.

- **Hardware:** Perfect Anodized aluminum pole, diameter 32mm, thickness 1.5mm, making the stand very stable and durable
- **Graphic material:** Polyester fabric
- Box design presents a high quality brand & image
- Tool-free assemble, fast and convenient
- Oxford bag packing

3m x 3m version is suitable for a 3m display space. However, we can custom to whatever size to fit your display demand. The biggest one we've done was 4.5m tall x 15m in width, 90cm in depth. That was a great experience for supplying this Monster Wall, and the best point is, unlike the building timber walls, this Aluminum structured wall is reusable, easy to pack up and storage for next event, thus a worthy investment.

3D Backwall



Display Set Up

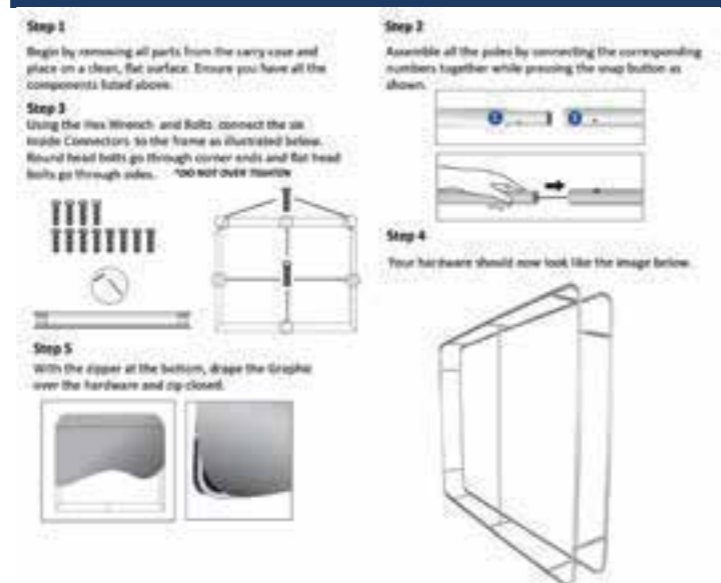

FW-2.3X6m-C



FW-2.3X6m-S



FW-2.3X3m



FW-2.3x1.5mU



FW-2.3x1.5m



FW-2.3x1.5mD



FW-1x0.9m

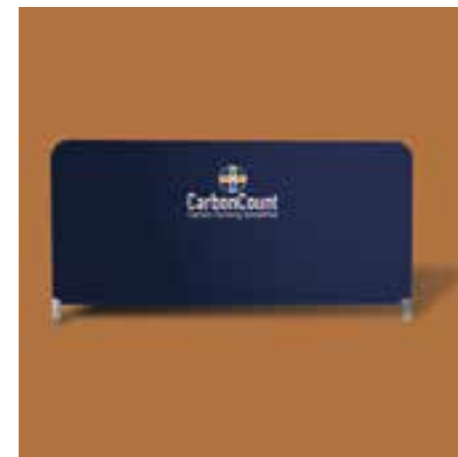

FW-2x0.9m



FDS-0.85x2m



FW-2X2m Round

FW- Size Single Side

1000 x 900mmH	\$159
1500 x 900mmH	\$189
2000 x 900mmH	\$209
1500 x 2300mmH	\$390
2300 x 2000mmH	\$490
2400 x 2300mmH	\$590
3000 x 2300mmH	\$590
4000 x 2300mmH	\$890
5000 x 2300mmH	\$990
6000 x 2300mmH	\$1190

FDS- Size Single Side

850 x 1500mmH	\$169
850 x 2000mmH	\$199
1200 x 1500mmH	\$209
1200 x 2000mmH	\$239

FWU/D- Size Single Side

1500 x 2300mmH	\$590
----------------	-------

FW-Round- Size Single Side

2000mmD	\$1390
---------	--------

Flag Banners



FLB-FT

Printing	Size	Flag Only	Whole Set
Single Side	XSmall 1.8m	\$39	\$60
	Small 2.3m	\$49	\$75
	Medium 3.0m	\$69	\$100
	Large 4.0m	\$99	\$155
	XLarge 4.6m	\$119	\$185
Double Side	XSmall 1.8m	\$69	\$80
	Small 2.3m	\$89	\$110
	Medium 3.0m	\$129	\$155
	Large 4.0m	\$179	\$225
	XLarge 4.6m	\$199	\$265



FLB-FF

Printing	Size	Flag Only	Whole Set
Single Side	XSmall 2.0m	\$39	\$65
	Small 2.5m	\$49	\$75
	Medium 3.5m	\$69	\$100
	Large 4.7m	\$99	\$155
Double Side	XSmall 2.0m	\$69	\$100
	Small 2.5m	\$89	\$110
	Medium 3.5m	\$129	\$155
	Large 4.7m	\$179	\$225



FLB-FR

Printing	Size	Flag Only	Whole Set
Single Side	Small 2.2m	\$69	\$95
	Medium 3.0m	\$89	\$120
	Large 4.3m	\$119	\$175
Double Side	Small 2.2m	\$109	\$130
	Medium 3.0m	\$149	\$175
	Large 4.3m	\$199	\$245

Product	Price
Silver Foldable Base	\$45
Premium Spike Base	\$35
Black Premium Cross Base	\$45*
V-shape Car Tyre Base	\$50
Wall Brackets (0°, 30°, 90°)	\$25
5kg Heavy Duty Square Base	\$50*
10kg Heavy Duty Square Base	\$65*

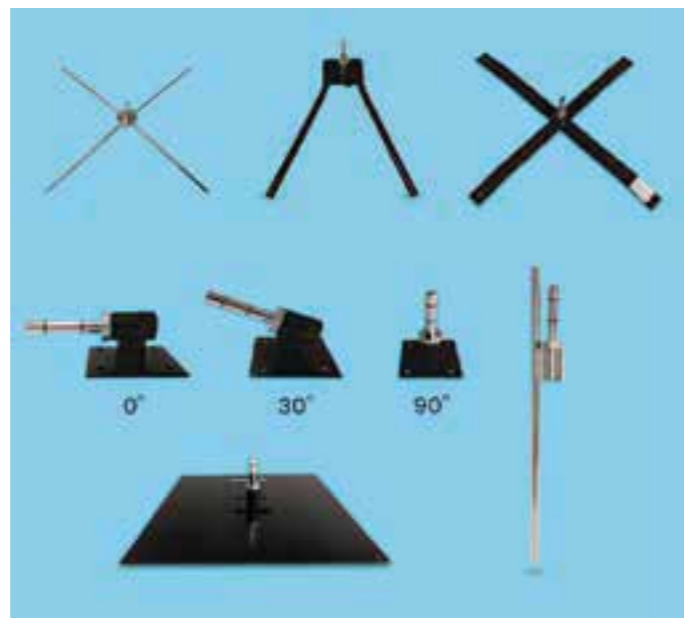

Flag Banners



FLB-B

Printing	Size	Flag with Pole	Add Bag
Single Side	Small 2.3m	\$60	\$72
	Medium 2.9m	\$85	\$97
	Large 3.7m	\$105	\$117
	XLarge 4.7m	\$125	\$137
Double Side	Small 2.3m	\$95	\$107
	Medium 2.9m	\$125	\$137
	Large 3.7m	\$145	\$157
	XLarge 4.7m	\$180	\$192



FLB-B

Printing	Size	Flag with Pole	Add Bag
Single Side	Small 2.8m	\$60	\$72
	Medium 3.2m	\$85	\$97
	Large 4.2m	\$105	\$117
	XLarge 5.2m	\$125	\$137
Double Side	Small 2.8m	\$95	\$97
	Medium 3.2m	\$125	\$137
	Large 4.2m	\$145	\$157
	XLarge 5.2m	\$180	\$192

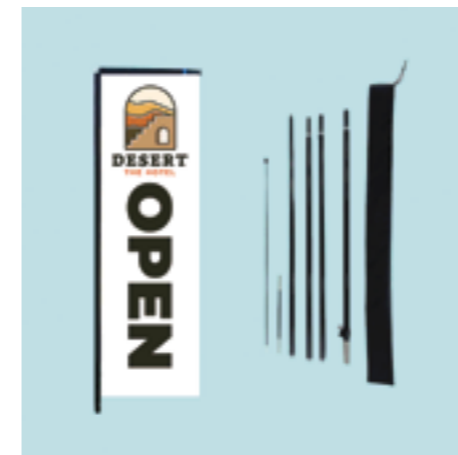

FLB-B

Printing	Size	Flag with Pole	Add Bag
Single Side	Small 1.2m	\$70	\$82
	Medium 2.1m	\$100	\$112
	Large 3.1m	\$115	\$127
	XLarge 4.1m	\$125	\$137
Double Side	Small 1.2m	\$95	\$107
	Medium 2.1m	\$125	\$137
	Large 3.1m	\$150	\$165
	XLarge 4.1m	\$160	\$172



Product	Price
10/15kg Water Bag	\$12/\$16
Standard Spike	\$20
Tent Mounting Base	\$65
Silver Fold Base + Water Bag	\$55
Black Cross Base + Water Bag	\$55
20L Heavy Duty Water Tank Base	\$65
Fence Base	\$55

Flag Banners



FLB-FB



Size	Single Side	Double Side
1000 x 3000mmH	\$490	\$650
1000 x 4000mmH	\$550	\$750
1000 x 5000mmH	\$690	\$890

Outdoor Giant Pole Flag Banner

- Package
Flag Banner with Telescopes Poles and Solid Water Fillable Base
- Flag Height
(A) 4.0 meters
(B) 5.4 meters
(C) 7 meters



BAAB



FLAG-RE



FP-S5



PS-Flag



FLB-FB



FP-Bunting

Backpack Flags



S-BB-T



S-BB-S



S-BB-F



S-BB-M

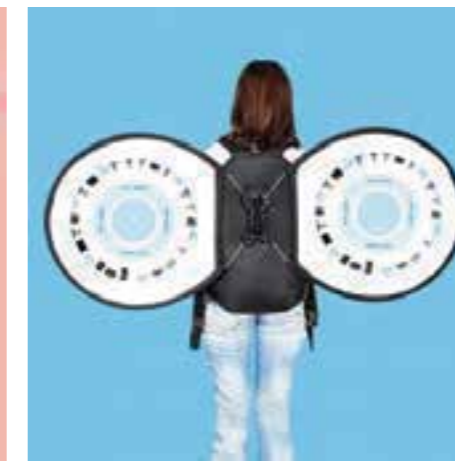

S-BB-O



S-BB-B

Product Code	Shape	Single Side	Double Side
S-BB-T	Teardrop Banner	\$179	\$219
S-BB-F	Feather/Shark Banner	\$179	\$219
S-BB-S	Straight Banner	\$179	\$219
S-BB-M	Spacial "M" Shape	\$199	\$249
S-BB-O	Spacial "O" Shape	\$199	\$249
S-BB-B	Spacial "B" Shape	\$199	\$249

BAAB	Size	Single Side/Double Side	BAAB	Size	Single Side/Double Side
	250 x 350mm	\$90/\$120		600 x 900mm	\$250/\$335
	300 x 450mm	\$110/\$150		800 x 1200mm	\$300/-
	400 x 600mm	\$160/\$210		900 x 1500mm	\$350/-
	500 x 750mm	\$200/\$270			



FP-Bunting Length	Single Side Printing	Double Sides Printing
5m	\$90	\$150
10m	\$150	\$250
20m	\$250	\$395
50m	\$500	\$750
100m	\$900	\$1350
>100m	\$8 per meter	\$9 per meter



FM3x3S4



FM3x3S1



FM3x3S2



FM3x6S2

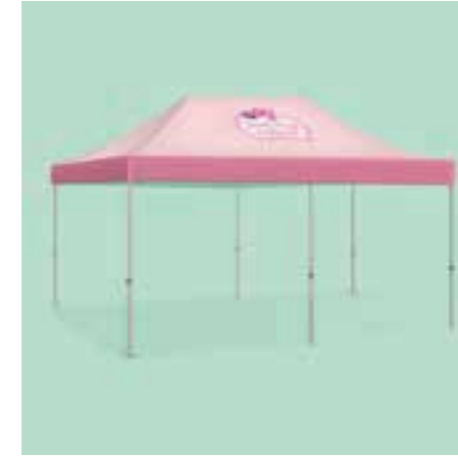

FM3x6S1



FM3x6S3



FM3x3S3



FM3x3S5

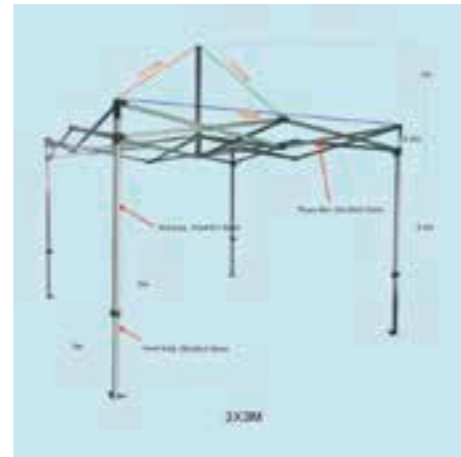

FM3x6S4

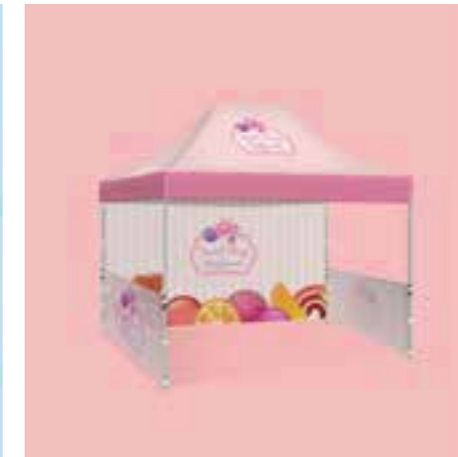

FM3x4.5S3



Product Code	Price
WB-2	\$39

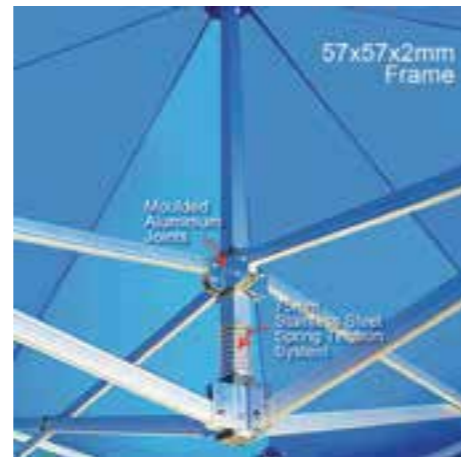

Product Code	Frame Size	Tube Thickness		
		4.5x4.5x1.0mm	4.5x4.5x1.8mm	5.7x5.7x2.0mm
FM3x3S1	3 x 3m	\$750	\$950	\$1150
FM3x3S2	3 x 3m	\$950	\$1150	\$1350
FM3x3S3	3 x 3m	\$1350	\$1550	\$1750
FM3x3S4	3 x 3m	\$1200	\$1400	\$1600
FM3x3S5	3 x 3m	\$1350	\$1350	\$1350
FM3x4.5S3*	3 x 4.5m	\$1750*	-	-
FM3x6S1	3 x 6m	\$1150	\$1450	\$1750
FM3x6S2	3 x 6m	\$1550	\$1850	\$2150
FM3x6S3	3 x 6m	\$1950	\$2250	\$2550
FM3x6S4	3 x 6m	\$1750	\$2050	\$2350

- Package Includes:**
- 1 X Marquee frame
 - 1x Full colour printed marquee cover
 - 4 X pegs & ropes
 - 1 X carry bag with wheels

Other sizes available on www.bigbanner.com.au

Shopping Centre Package



SCP-01

SCP-01 Promotional Table with Header

+ 1x Standard Silver Pull Up Banner + Brochour Holder	\$570
+ 2x Standard Silver Pull Up Banner + Brochour Holder	\$700
+ 1x Deluxe Silver Pull Up Banner + Brochour Holder	\$600
+ 2x Deluxe Silver Pull Up Banner + Brochour Holder	\$770

SCP-01-1 2000x1400mm/2000x2000mmH Deluxe Pull Up Banner

+ 1x Portable Round Printed Counter + 1x Brochure Holder	\$920/1000
+ 2x Portable Round Printed Counter + 1x Brochure Holder	\$1250/1350
+ 1x Portable Round Printed Counter + 2x Brochure Holder	\$1020/1100
+ 2x Portable Round Printed Counter + 2x Brochure Holder	\$1350/1450

SCP-02 Standard Promotional Table

+ 2000 x 1400mmH Backdrop with Adjustable Fame	\$735
+ 2000 x 2000mmH Backdrop with Adjustable Fame	\$825

SCP-03 2000x1400mm/2000x2000mmH Deluxe Pull Up Banner

+ Easy Setup Promotional Table + Brochure Holder	\$950/1000
+ Easy Setup Promotional Table Large Vision + Brochure Holder	\$1050/1150



SCP-01-1



SCP-02



SCP-03-200



SCP-03-140

Expo Event Package



EXPO-01



EXPO-03



EXPO-04



PVC Popup Wall Exhibition Package EXPO-01

- Exhibition display stands utilize aluminium framing for durable, lightweight displays
- Vivid full colour custom graphic on vinyl printing mounted on panels
- PA digitally printed unit requires no tools for assembly

EXPO-01 From \$2260

- 3 x 3mH Curve/Straight Medial Wall
- Standard Silver Pull Up Banner
- Standard 1mD Prize Wheel with Logo Panel
- Brochure Holder



EXPO-03 From \$1480

- 3 x 2.3mH Straight/Curve Display Wall
- Instant Pop Up Promotional Table
- Deluxe Silver Pull Up Banner
- Brochure Holder

EXPO-04 From \$2500

- 6 x 2.3mH Portable Fabrica Wall
- 1.6mW x 1mH x 0.52mD Portable Slimline Display Table
- Standard 1mD Prize Wheel with Logo Panel
- Standard Sliver Pull Up Banner

Expo Event Package



SSF

EXPO Booth Graphic | Shell Scheme Fabric Graphics

Shell wall graphics are a great way to use your designs to bring your exhibition shell scheme to life and attract potential customers to your stand. Fabric graphics are made from top quality materials and are finished with velcro fixings required to attach your graphics walls to the shell scheme.

- Printed on premium 260gsm satin fabric – velcroed on all four sides.
- Seamless mural-style graphics
- Lightweight fabric – easy and light to transport
- Attaches directly to shell scheme carpet wall (LOOP) using Velcro-HOOK stitched to the fabric
- 380GSM PVC print for header option

SSF Size	Velcro Edge-Hook Side	Velcro Hook Sewing+Loop Side
2880 x 2400mmH	\$490	\$520
5760 x 2440mmH	\$885	\$950
5855 x 2400mmH	\$885	\$950
8640 x 2440mmH	\$1150	\$1250
8735 x 2440mmH	\$1150	\$1250
11615 x 2400mmH	\$1650	\$1800
2990 x 300mmH (Header)	\$160	\$180

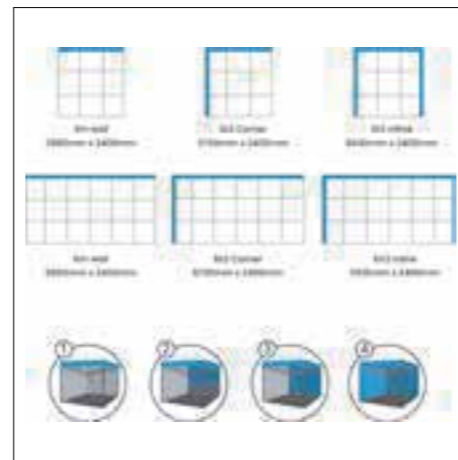

Expo Event Package



OIE

Expo Modular Stand Graphic | Octanorm Infills for Exhibitions

Famous for promoting products at shopping centres, supermarkets, etc., effective tool for trade shows, exhibition shows and events. Made with quality PVC and is easy to set up. Smart business promotional choice, great value.

- 380GSM PVC shell scheme graphics for different size back walls
- Affordable way to transform a shell scheme back wall
- Edge-to-edge coverage
- Custom-made panels to suit your specification
- Rollable graphics – easy to store and transport
- No tools required for installation
- Bubble wrapped and supplied in a cardboard box
- Attaches directly to shell scheme wall

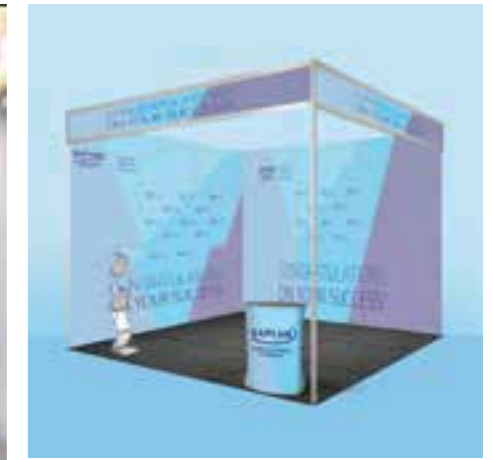

OIE Size	Price
970 x 2280mmH	\$120
960 x 2400mmH	\$125
950 x 2340mmH	\$125
950 x 2400mmH	\$125
2990 x 300mmH (Header)	\$125

Expo Rigging Banner



HB-Cube

Expo Ceiling Banner

- Tension Fabric Hanging Banner is a great way to increase your message and brands visibility at trade shows and events, helping potential clients find the location of your trade show booth from any position in the trade show area
- Attract attention to your stand
- Full colour printing on stretch fabric with a zip around the edge
- Can be single sided printing or double sided printing
- Include aluminum frame and rigging points
- Easy to install, lightweight and very impressive
- Carry bag is included

HB-Cube Size	Price
800 x 600 x 600mm	\$750
1000 x 800 x 800mm	\$850
1400 x 1200 x 1200mm	\$1150
800 x 800 x 800mm	\$850
1000 x 1000 x 1000mm	\$950
1000 x 1000 x 1000mm	\$1350



HB-C



HB-Sq



HB-Tri

Porduct Code	Size	Single Sided Printing	Double Sided Printing
HB-C	2400mmD x 1000mmH	\$990	\$1450
HB-C	3000mmD x 1000mmH	\$1200	\$1650
HB-C	3600mmD x 1000mmH	\$1450	\$1950
HB-Sq	2400mmL x 2400mmW x 1000mmH	\$990	\$1450
HB-Sq	3000mmL x 3000mmW x 1000mmH	\$1200	\$1650
HB-Sq	3600mmL x 3600mmW x 1000mmH	\$1450	\$1950
HB-Tri	2400mmL x 2400mmW x 1000mmH	\$990	\$1450
HB-Tri	3000mmL x 3000mmW x 1000mmH	\$1100	\$1650
HB-Tri	3600mmL x 3600mmW x 1000mmH	\$1200	\$1750

Outdoor Event Package



OEP-01



Style 1



Style 2



Style 3

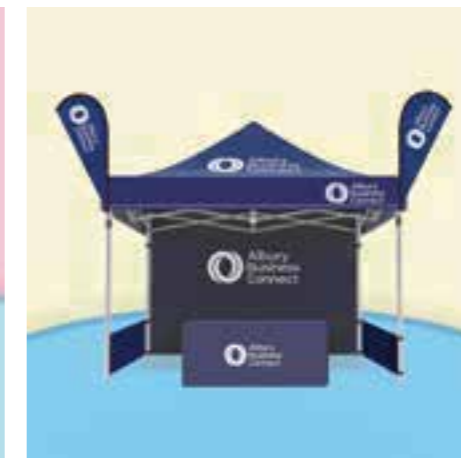

Style 4



Style 5

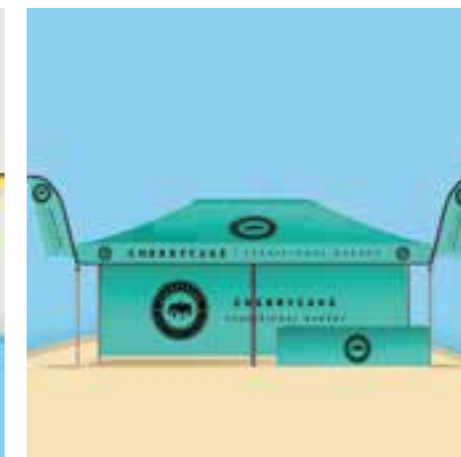

Style 6

Popular Tent Options

- Stand out amongst the crowd with an event ready custom outdoor event package
- Built to make you capture more business during your trade shows

Package Style	Price
Style 1	\$1280
Style 2	\$1220
Style 3	\$1560
Style 4	\$1680
Style 5	\$2800
Style 6	\$2800



FTV-01



PL01



FTV-02



BAHB-100



Artboard-A4A3



PVC-A



BAHF-300



BKB



CHA-W

Crowd Control | Queue Barriers

These premium quality stainless steel crowd control stands are popular for business with crowd management needs.

- 4-way connectivity design
- Easily assemble
- 320mm diameter base
- Rubber base to avoid scratches on floor
- Durable metal plate cover on base to add weight
- Height: 1000mm
- Material: chrome finished stainless steel
- Weight: 7.5kg

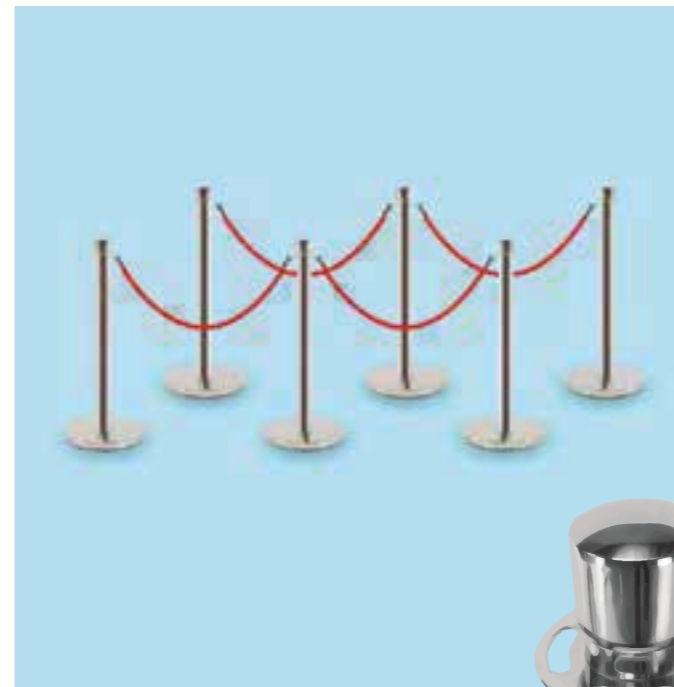

CROWNR \$60
Rod with Base



1.5m Velvet Rope @\$29ea

Retractable Queue Barriers | Crowd Control

- 4-way connectivity design
- In-built 2000mm x 48mm red/black retractable belt
- Effortlessly assemble
- 320mm diameter base
- Rubber base to avoid scratches on floor
- Durable metal plate cover on base to add weight
- Height: 920mm
- Material: gloss chrome finished stainless steel
- Weight: 7.5kg



CROW-R \$65
Rod with Base & Belt



Sign Holder
UFY-SSA3 | UFY-SSA4
A4: \$38
A3: \$48



Floor Stands



PS-100169 | PS-100169F | PS-10043 | PS-10043F From \$245



IPAD-BW From \$329



STP-LCD From \$2400



FS-A3 From \$125*



CPS-A3/A4 From \$189



TVS1810B(Stand Only) From \$945



TVS3258(Stand Only) From \$235



DMAD(Stand Only) From \$155



BH-AMS From \$145

Snap Frames



HP-S



RSF-S



HP-B

Heavy Duty Clip Frame | Poster Holder | 32mm Profile | Portrait & Landscape

Size	Silver Square	Silver Round	Black Square
A4	\$20	\$19	\$20
A3	\$25	\$25	\$25
A2	\$39	\$39	\$39
A1	\$52	\$49	\$52
A0	\$82	\$80	\$85



Aluminium Poster Hanger (2pcs/set)

- Ideal for retail display, shopping centre, shop ceiling, etc.
- Aluminum snap frame allows quick poster changes

Size	Price
420mm A2	\$9
600mm A1	\$15
850mm A0	\$25
1000mm	\$29
1200mm	\$36



PH-60

BigBanner

Display & Printing

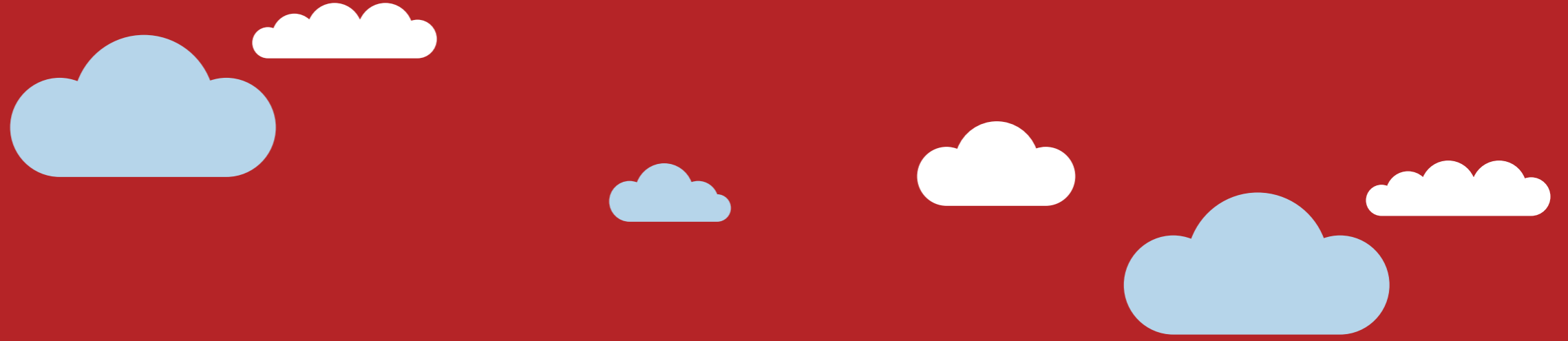

Cafe Barriers | Wind Break



CB-1mx1m-B



CB-2mx1m-B



CB-2n2-B



CB-1mx1m-S



CB-2mx1m-S



- **Material:**
Black/Silver UV Powder Coated tube with Vinyl Banner
- **Printing Options:**
 - No Printing (Choice of solid colour)
 - Single Side Printing
 - Double Side Printing

Product Code	Frame Size	Incl. SS Print	Incl. DS Print
CB-1mx1m-B	1000 x 940mm	\$275	\$315
CB-1mx1m-S	1000 x 940mm	\$275	\$315
CB-2mx1m-B	2000 x 940mm	\$335	\$375
CB-2mx1m-S	2000 x 940mm	\$335	\$375
CB-2n2-B	1m+2m+2m+1m	\$1250	\$1350
CB-2n2-S	1m+2m+2m+1m	\$1250	\$1350
CB-2n2-SQ	1m+2m+2m+1m	\$1380	\$1480

Cafe Barriers | Wind Break



CB-1mx1.5m



CB-1mx1m-SQ



CB-2mx1.5m

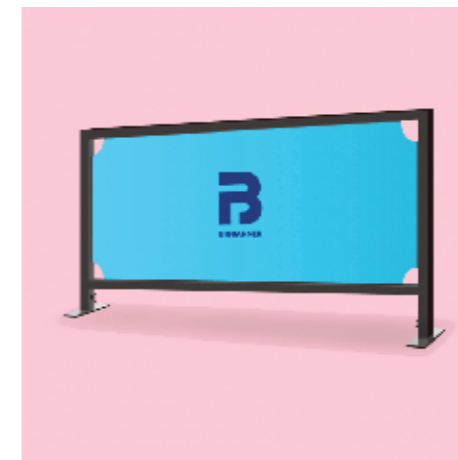

CB-2mx1m-SQ

Solid colour banner Options:

- Red
- Blue
- Black
- Grey
- White
- Cream
- Brown
- Maroon

● **Material:**

- 1m Height - Black UV Powder Coated tube with PVC film
- 1.5m Height - Black UV Powder Coated tube with Clear Film on Top and Colour/Printed PVC Banner on Bottom

● **Printing Options:**

- No Printing (Choice of solid colour)
- Single Side Printing
- Double Side Printing

Product Code	Frame Size	Incl. SS Print	Incl. DS Print
CB-1mx1m-SQ	1000 x 940mm	\$300	\$345
CB-2mx1m-SQ	2000 x 940mm	\$385	\$425
CB-1.5mx1m	1000 x 1500mm	\$550	\$600
CCB-1.5mx2m	2000 x 1500mm	\$680	\$780

Product Code	Description	Price
Feet-D	250mm Double Feet	\$35
Feet-S	250mm Single Feet	\$30
Feet-S	300mm Single Feet	\$35

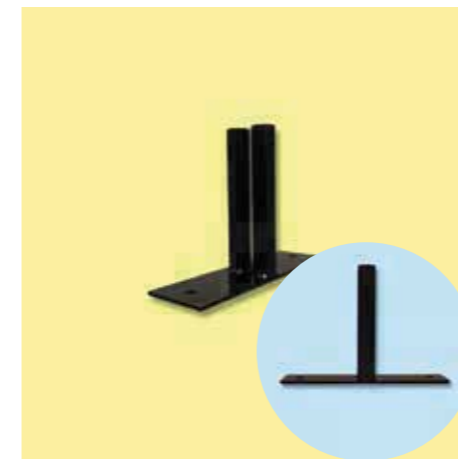

Feet-D/Feet-S

Economic Umbrellas



UMB-2x2-E

Square Economic Umbrella Hexagon Aluminium Frame | Valance (2x2m)

- Canopy size 2mx2m with full colour customized printed logo, text or photos
- 190mm H full colour customized printed valance included
- Anodized aluminium frame which is lightweight and completely rust-free
- The frames come with 4 easy-slide height-adjustment system
- 2-year warranty on frames
- Bases are selling separately
- Base comes with round tube, will not 100% match the rod of the umbrella. We recommend you to use cardboard or cloth to wrap and secure the rod to the base sleeve
- Inspections can be arranged in our Melbourne warehouse showroom

Product Code	UMB-2x2-E
Umbrella Size	2.0 x 2.0m_2.44H
Black Canopy + Frame + 4 Logo on Top	\$385
Black Canopy + Frame + 4 Logo on Valance	\$345
Full Colour Printed Canopy + Frame	\$415

Product Code	Description	Size	Price
UMB-B	Umbrella Base	450 x 450mm	\$95
UMB-B	Umbrella Base	600 x 600mm	\$115

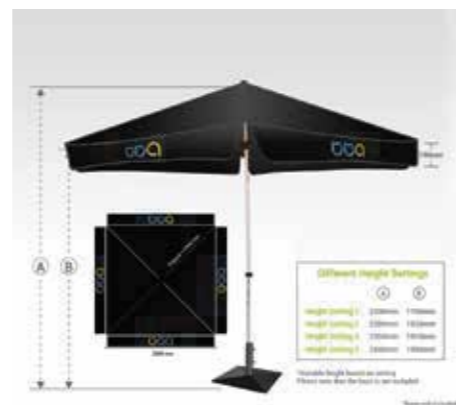

UMB-B

Commercial Umbrellas



UMB-2x2



UMB-3x3



Colour Choice



WB-1



InGrd Socket

The Instant Shade commercial-grade high quality aluminium-framed “market” umbrellas are the ideal shade solution for your outdoor living space.

Commercial Quality and Great Value

Perfect for commercial or residential use to protect you from the harsh Australian sun. The same umbrellas used by cafes, restaurants and resorts all over Australia are also available for your own deck, courtyard, balcony and pool areas at home.

The Frame

The umbrella frames are stylish anodised aluminium which is lightweight and completely rust-free. The frames come with a 2-year warranty.

Weather, Water and UV Resistant Canopy

The canopies are made of water repellent and UV-resistant long-lasting materials. Canopies come with a variety of stylish colours as well.

Product Code	UMB-2x2
Umbrella Size	2.1x2.1m_2.75H
Polyester Canvas + Frame	\$390
Polyester Canvas with Valance + Frame	\$450
Acrylic Canvas + Frame	\$435
Acrylic Canvas with Valance + Frame	\$495

Product Code	UMB-3x3
Umbrella Size	3x3m_3H
Polyester Canvas + Frame	\$630
Polyester Canvas with Valance + Frame	\$710
Acrylic Canvas + Frame	\$730
Acrylic Canvas with Valance + Frame	\$810

Product Code	Description	Weight	Price
WB-10	Weight Bag Sand Bag	10kg	\$38.5
WB-15	Weight Bag Sand Bag	15kg	\$49.5
InGrd Socket	Umbrella Inground Socket & Sleeves	-	\$265

Roll-up Banner



RS-2L-M

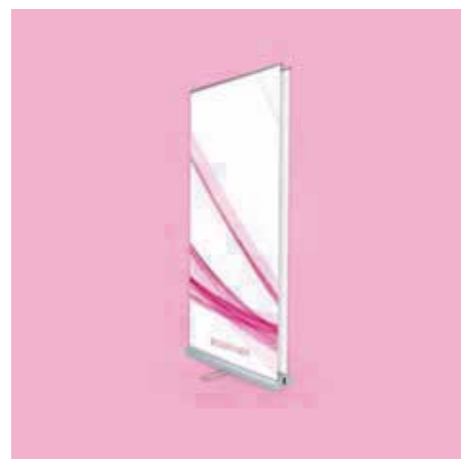

RS-2L-M-DS



RS-2L-M-B



RU-B-85



RU-S-85



RU-S-A3/A4



RU-S-15



RU-S-200

Product Code	Image Size	Frame	Price
RS-2L-S	600 x 1600mm	Silver	\$90
RS-2L-M	850 x 1400mm	Silver	\$99
RS-2L-M	850 x 2000mm	Silver	\$119
RS-2L-L	1000 x 1400mm	Silver	\$149
RS-2L-L	1000 x 2000mm	Silver	\$149
RS-2L-XL	1200 x 2000mm	Silver	\$199
RS-2L-M-B	850 x 1400mm	Black	\$129
RS-2L-M-B	850 x 2000mm	Black	\$129
RS-2L-M-DS	850 x 1400mm	Silver	\$219
RS-2L-M-DS	850 x 2000mm	Silver	\$219

Product Code	Image Size	Frame	Price
RU-S-A4	210 x 297 mm	Silver	\$24*
RU-S-A3	297 x 420 mm	Silver	\$30*
RU-S-85	850 x 1400mm	Silver	\$165
RU-S-85	850 x 2000mm	Silver	\$165
RU-S-100	1000 x 1400mm	Silver	\$195
RU-S-100	1000 x 2050mm	Silver	\$195
RU-S-120	1200 x 2050mm	Silver	\$295
RU-S-150	1500 x 2050mm	Silver	\$475
RU-S-200	2000 x 2000mm	Silver	\$465
RU-B-85	850 x 1400mm	Black	\$179
RU-B-85	850 x 2000mm	Black	\$179
RU-B-150	1500 x 2000mm	Black	\$419

Roll-up Banner



RU-8S-85



XB-C-600



RU-8S-200



RU-8B-85

Product Code	Image Size	Frame	Price
RU-8S-85	850 x 1400mm	Silver	\$185
RU-8S-85	850 x 2000mm	Silver	\$215
RU-8S-300	3000 x 2400mm	Silver	\$1450
RU-8B-85	850 x 1400mm	Black	\$239
RU-8B-150	1500 x 1400mm	Black	\$369
RU-8B-150	1500 x 2100mm	Black	\$419
RU-8B-200	2400 x 2000mm	Black	\$900
RU-8B-300	3000 x 2400mm	Black	\$1650
RU-S-85-DS	850 x 1400mm	Silver	\$339
RU-S-85-DS	850 x 2000mm	Silver	\$339
RU-S-120-DS	1200 x 1400mm	Silver	\$459
RU-S-120-DS	1200 x 2000mm	Silver	\$459

RU-8S-300



RU-8B-300



RU-S-85-DS



XB-Mini

Product Code	Image Size	Frame	Price
XB-Mini	250 x 420mm	Silver	\$99/4pcs
XB-C-600	600 x 1600mm	Black	\$90
XB-C-800	800 x 1800mm	Silver	\$159



A6090



A017BB



A120180



AF016-W



AR6045

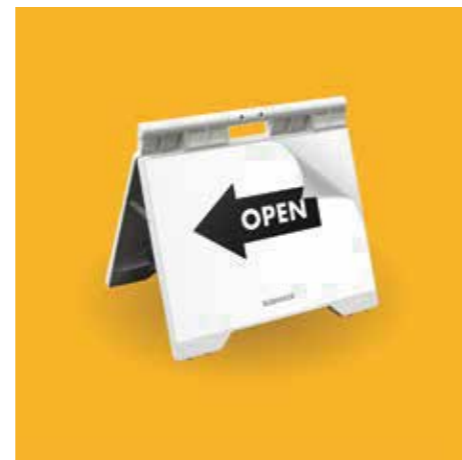

ES600



A6045



ILS-T



AT6090



POP-R



WPS-SF



WPS-460



POP-Tri

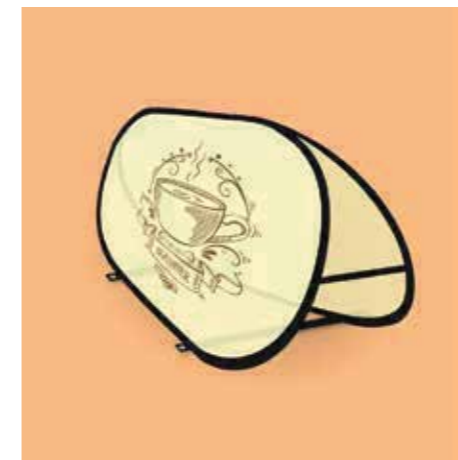

POP-O



Verti-01

Product Code	Image Size	Price
POP-R	Round 1000mmD	\$199
POP-R	Round 1200mmD	\$299
POP-R	Round 1500mmD	\$479
POP-Tri	Triangle 1000 x 1000mm	\$199
POP-Tri	Triangle 1200 x 1200mm	\$299
POP-Tri	Triangle 1500 x 1500mm	\$479
POP-O	Oval 1200 x 700 mm	\$199
POP-O	Oval 2000 x 1000 mm	\$299
POP-O	Oval 2600 x 1100 mm	\$479
Verti-01	Vertical 600 x 900mm	\$199
Verti-01	Vertical 1000 x 1700mm	\$299
Verti-01	Vertical 1250 x 2000mm	\$479

Product Code	Image Size	Price
A6045	600 x 450mm	\$135
A6090	600 x 900mm	\$175
A90120	900 x 1200mm	\$295
AT6090	600 x 900mm	\$165
AF016-W	610 x 850mm	\$255
AF016-B	610 x 850mm	\$255
A017BB	600 x 900mm	\$200
AR6045	590 x 435mm	\$135
ES-600	600 x 450mm	\$155
WPS-SF	594 x 841mm	\$319
WSH-460	460 x 783mm	\$185
ILS-T	600 x 900mm	\$165

Product Code	A120180
Image Size	1200 x 1800mmH
Frame Only	\$300
Frame + 2 Blank Panel	\$460
Frame + Double Side Print	\$750
Frame + Double Side Print + 2 Wheels	\$830
Frame + Double Side Print + 2 Wheels + 2 Handels	\$860

Corflute Panel

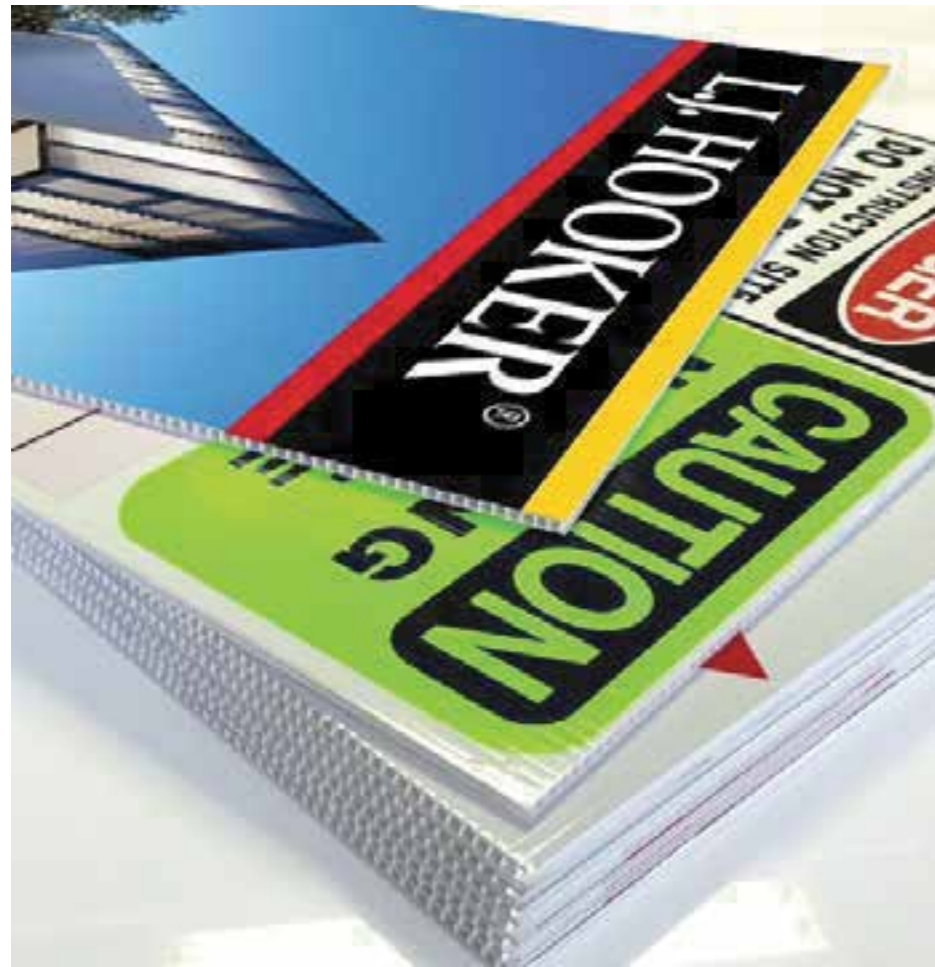

Corf-SIGN



Corf-BS



Corf-SIGN-CO



AF-WIRE



Corf-TS



Corf-SC

Corf-Sign (5mm)	QTY	Without / With Eyelets
2400 x 1220mm	1 pc	\$180/\$190
813 x 1200mm	3pcs	\$200/\$210
600 x 1200mm	4pcs	\$200/\$210
600 x 900mm	5pcs	\$200/\$210
Corf-SC (3mm)	QTY	Price
300 x 300mm	3	\$100
400 x 400mm	3	\$135
500 x 500mm	3	\$160
580 x 580mm	3	\$180

AF-WIRE	QTY	Single/Double Side
400 x 300mm	12 pc	\$145/\$195
600 x 400mm	12pcs	\$245/\$315
Corf-BS	QTY	Price
1000 x 270mm	4/10pc	\$150/\$255
1200 x 300mm	4/10pcs	\$160/\$299
Corf-TS	QTY	Price
1200 x 650mm (Face)	1-5pcs	\$155 ea
1800 x 400mm (Face)	1-5pcs	\$175 ea
2400 x 400mm (Face)	1-5pcs	\$185 ea

Foam Panel



Foam-Sign



Foam-Sign



Corf-CO



SMCO-800



SMCO-800



SMCO-S



CH-05

SMCO-800	Options	Price
800 x 1200mm	5mm Corflute	\$119
800 x 1200mm	10mm Foam Board	\$139
900 x 2000mm	10mm Foam Board/with Free Standing	\$220/285
SMCO-S	Options	Price
900 x 1200mm	10mm Foam Board with Free Standing	\$400
900 x 2000mm	10mm Foam Board with Free Standing	\$500
CH-05	No Lamination	With Gloss Lamination
450 x 1000mm	\$99	\$159
500 x 1400mm	\$169	\$249

Vinyl Banner



VB-SS



VB-DS



VB-HB



Product Code	Size	Price
VB-HB	1500 x 5000mm	\$395
VB-HB	1500 x 10000mm	\$750
VB-HB	1800 x 5000mm	\$450
VB-HB	1800 x 10000mm	\$795
VB-HB	2000 x 5000mm	\$495
VB-HB	2000 x 10000mm	\$890
VB-HB	2400 x 10000mm	\$1240
VB-HB	3000 x 10000mm	\$1260

Product Code	Size	Trim to Size	Reforced Edges & Eyelets	Velco Male/Female
VB-SS	1500 x 5000mm	\$365	\$445	\$490
VB-SS	1500 x 10000mm	\$675	\$825	\$985
VB-SS	2000 x 5000mm	\$490	\$550	\$650
VB-SS	2000 x 10000mm	\$900	\$1100	\$1240

Finish Option



Mesh Banner



MB-350

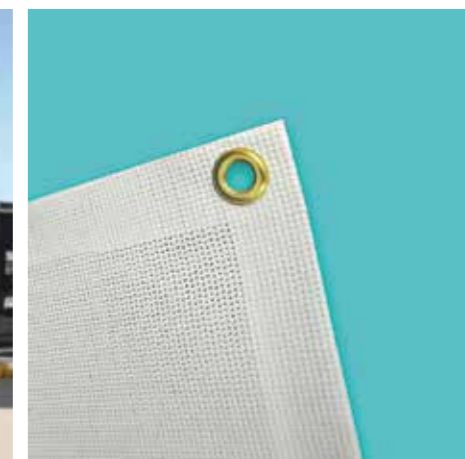

Material:

- **PVC Mesh Banner:** 12 x 12 Mesh Panels (small holes)
6 x 6 Mesh Panels (large holes)
- **The difference between 12x12 & 6x6 Mesh**
12x12 Mesh is a more close-knit mesh banner stock. The smaller perforations mean that the print image visibility is very high, however the trade-off is that less air flows through the banner. This is 'premium' mesh that may not be the best option for extremely windy environments. In contrast, 6x6 Mesh is considered an open weave mesh. The larger perforations allow more air to move through and is ideal in higher wind load installs. However, due to the nature of the open weaves, there is less surface to print on so there is less actual print, making the image less sharp and vivid.

MB-350 Popular Size	Price
1.6m x 2.4mW	\$150
1.6m x 5mW	\$250
1.6m x 10mW	\$480
1.6m x 50mW	\$850
1.8m x 2.4mW	\$150
1.8m x 5mW	\$250
1.8m x 10mW	\$480
1.8m x 50mW	\$850

Fabric Printing



MB-F

Outdoor Mesh Banner (Fabric Mesh)

Material

Fabric Mesh Outdoor Banner (Short term Use)

Finishing

- Hemmed edges with eyelets per 500mm (Free)
- 50mm rod pockets (Free)
- Ropes and eyelets (quote for cost)
- Custom requirements (quote for cost)

Product Code	Popular Size	Price
MB-F	1.6m x 3mW	\$240
MB-F	1.6m x 5mW	\$400
MB-F	1.6m x 10mW	\$800
MB-F	1.6m x 40mW	\$2400



FB-P

Custom-made Fabric Banner Printing

- Digital Print | Dye Sublimation | Heat Transfer
- Several fabrics to choose
- Single-sided or Double-sided
- Outdoor or Indoor use

Please contact us for fabric sample book

Finishing Options



Silicone Keder Edge

Hemmed and Eyeleted

Pocket

Velcro

Table Covers

Loose Table Cover / Premium Printed Table Throws

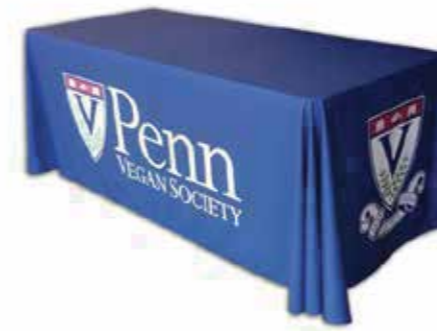

- Full colour dye-sub print
- Quality 260gsm fabric
- Finishing: hemmed edges
- Made in Australia
- 4-Sided table throw fits a 4ft, 6ft or 8ft table for a professional look

Suitable for standard trestle tables:

- 4 ft: 1220mm W x 615mm D x 740mm H
- 6 ft: 1830mm W x 762mm D x 740mm H
- 8 ft: 2440mm W x 762mm D x 740mm H



TC-01

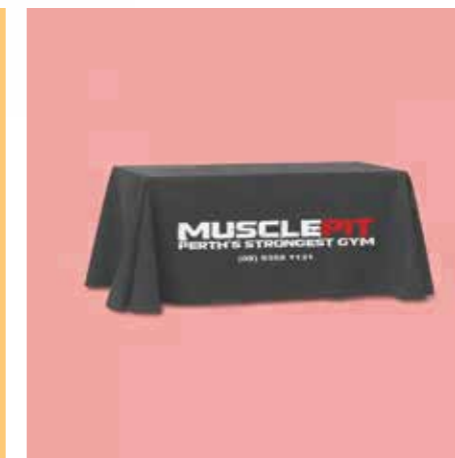

TC-02



TC-03



TC-04

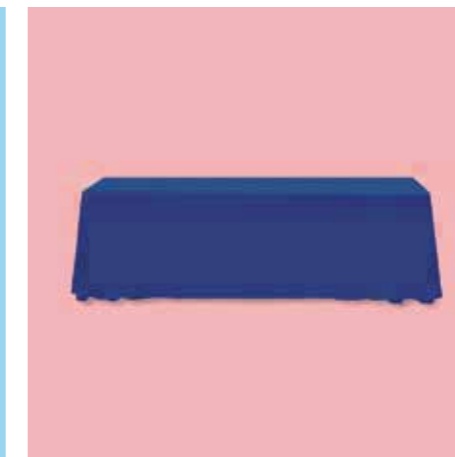

TT-09



TT-11

Cover Styles	4ft table	6ft table	8ft table
TC-01	-	\$169	\$199
TC-02	\$129	\$169	\$199
TC-03(Without Zip)	\$195	\$229	\$249
TC-03(With Zip)	\$225	\$259	\$279
TC-04(Open Back)	\$129	\$169	\$199
TC-04(Close Back)	\$159	\$199	\$229
TT-09(White/Blue/Red/Black)	-	\$79	\$99

Cover Styles	400 x 2000mml	600 x 2000mml	800 x 2000mml	1000 x 2000mml
TT-11	\$99	\$119	\$149	\$179

Please contact us for sizes not listed above

Digital Printing



BC350 From \$85.00



A4CBL From \$159.00



A4HCBL From \$579.00

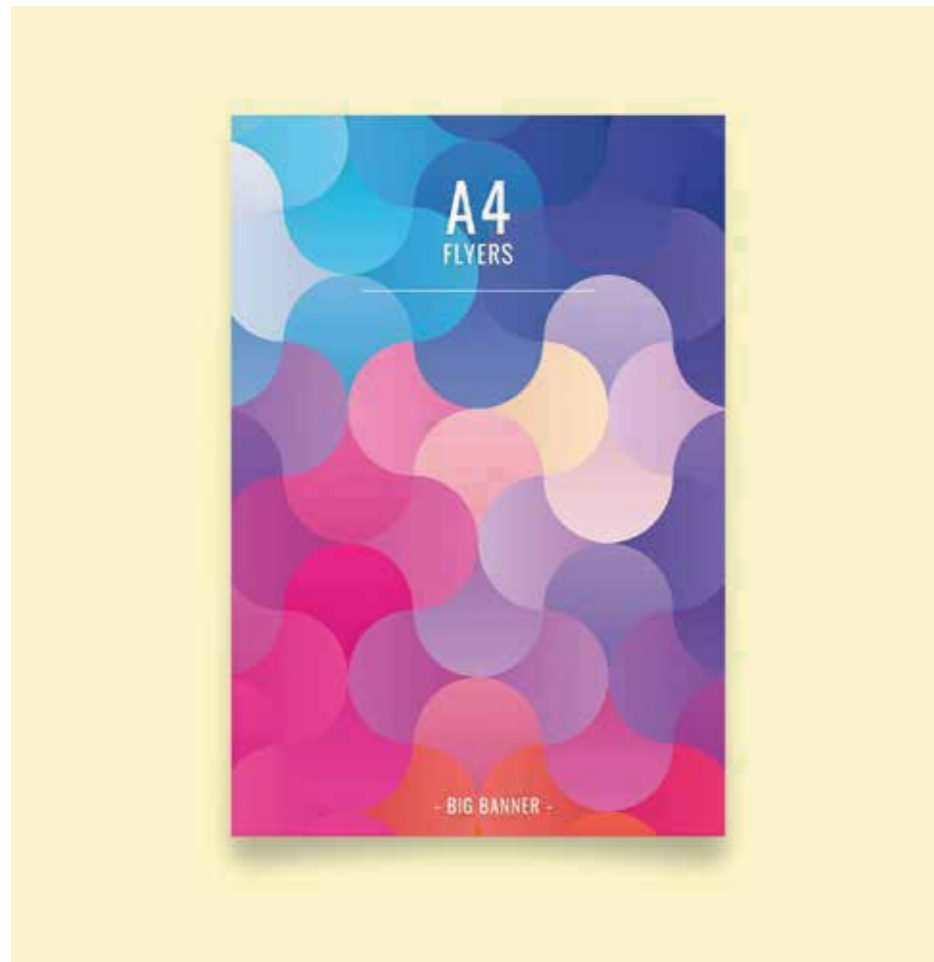

001FA4 From \$139.00



PRFOA4 From \$680.00



NCRINV From \$252.00

Large Format Posters



PO190

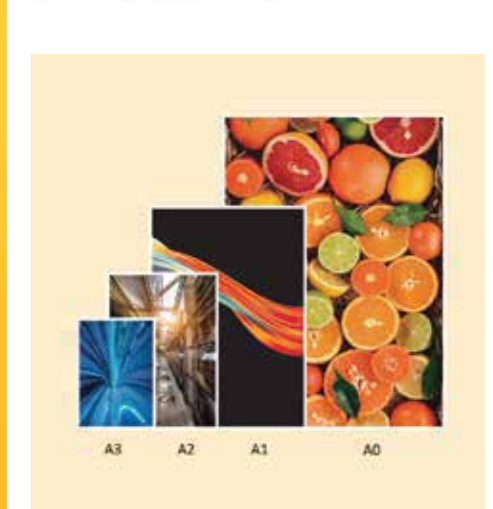
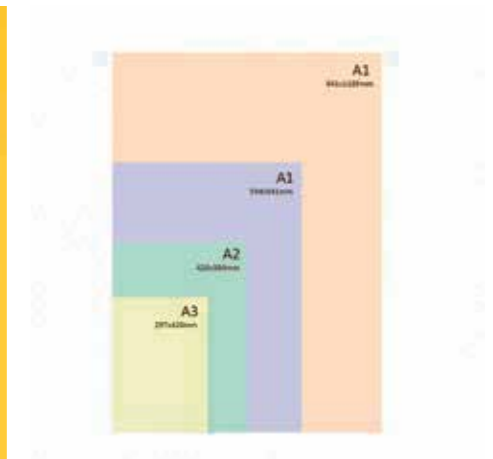

PO190

PO190 QTY	A0	A1	A2	A3
4pcs	\$90	\$90	\$80	\$80
6pcs	\$100	\$90	\$80	\$80
10pcs	\$135	\$110	\$90	\$90
20pcs	\$255	\$205	\$145	\$120
40pcs	\$495	\$380	\$245	\$148
50pcs	\$620	\$475	\$295	\$172
75pcs	\$915	\$555	\$385	\$230
100pcs	\$1135	\$720	\$500	\$285

PO170 QTY	A1	A2	A3
125pcs	\$884.50	\$506.05	\$172.55
250pcs	\$932.35	\$530.70	\$195.75
500pcs	\$1032.40	\$581.70	\$304.50
1000pcs	\$1234.40	\$674.25	\$429.20
2000pcs	\$1641.40	\$891.75	\$588.25
3000pcs	\$2014.05	\$1058.50	\$680.05
4000pcs	\$2385.25	\$1174.50	\$804.75
5000pcs	\$2756.45	\$1355.75	\$920.75



PO170



HP-S

Poster Frame refer to page 58

Label & Sticker



Full Colour Paper Sticker

Mass production (without Lamination)

- Colour: CMYK full colour printing
- Size: minimum 30x30mm each sticker
- Corner: square or round corners
- Shape: square, rectangle, circle, oval
- Supply: Sheet
- Optional: gloss or matt lamination, (Extra Charge) customized shapes, Supply by roll



Size(mm)	500 pcs	1,000 units	2,000 units	5,000 units	10,000 units	20,000 units
40x40	\$115	\$135	\$165	\$270	\$460	\$825
50x50	\$130	\$160	\$205	\$345	\$535	\$955
60x60	\$140	\$180	\$240	\$450	\$665	\$1,190
50x90	\$155	\$200	\$285	\$490	\$785	\$1,400
60x90	\$160	\$220	\$320	\$530	\$920	\$1,645
70x70	\$155	\$210	\$290	\$495	\$810	\$1,450
80x80	\$175	\$250	\$365	\$610	\$1,085	\$1,925
90x90	\$185	\$280	\$430	\$707	\$1,290	\$2,310
100x100	\$227	\$355	\$550	\$965	\$1,750	\$3,130
80x100	\$185	\$275	\$415	\$690	\$1,250	\$2,240
50x150	\$180	\$260	\$400	\$660	\$1,185	\$2,120
100x150	\$260	\$415	\$585	\$1,275	\$2,105	\$3,765
120x120	\$265	\$435	\$615	\$1,338	\$2,230	\$3,990
150x150	\$340	\$535	\$800	\$1,600	\$3,115	\$5,575
100x200	\$415	\$636	\$1,155	\$2,365	\$4,660	\$8,340
250x250	\$535	\$880	\$1,490	\$3,185	\$6,250	\$11,185
300x300	\$775	\$1,390	\$2,580	\$6,105	\$11,575	\$20,720

Please contact us for sizes not listed above

Label & Sticker



Personal Care



Logistics



Food



Beverage



Custom Shapes
Polymeric Vinyl



Industrial
Monomeric/Hi-Tack Vinyl



Transparent with White Ink Polymeric/Removable Clear Vinyl



Real Estate



Promotional & Bumper Stickers
Polymeric/Monomeric Vinyl

Graphic Solution



1



2



3



4

- 1.Window Graphic Print (Cut Out)
- 2/5.Customized Wall Display Solutions
- 3.Frosted Glass Vinyl Graphic Film
- 4.High Resolution Floor Graphic
- 6/11.Brick Wall & Concrete Surface Graphic Sticker
- 7.Real Estate SOLD Labels | Auction Stickers
- 8.High Resolution Wall Graphi
- 9.One Way Vision (Micro Hole) Stickers
- 10.Window Graphic Print (Total Image)

Graphic Solution



5



6



7



8



9



10



11

Promotional Gifts



Gifts & Promotions



Swiss Peak Tornado 58cm Umbrella



Swiss Peak TWS Earbuds



Notebook



Relax Candle



Deluxe Mouse Mat (3mm thickness)



Highland Whisky Glass Set



Bambu Phone Holder



Coloured Pencil Tube



Bamboo Wine Waiters Knife



Bobby Wireless Speaker



Harmony Gift Set



Alfresco Picnic Blanket



Alpine Cooler Bag



Smart Sports Bracelet



Key Ring



Swiss Peak 38cm Laptop Bag



Kyoto 3 in 1 Cable Keyring



Branded Crystal Trophy

Gifts & Promotions



Name Tag with Lanyard



Colour Max Lanyard

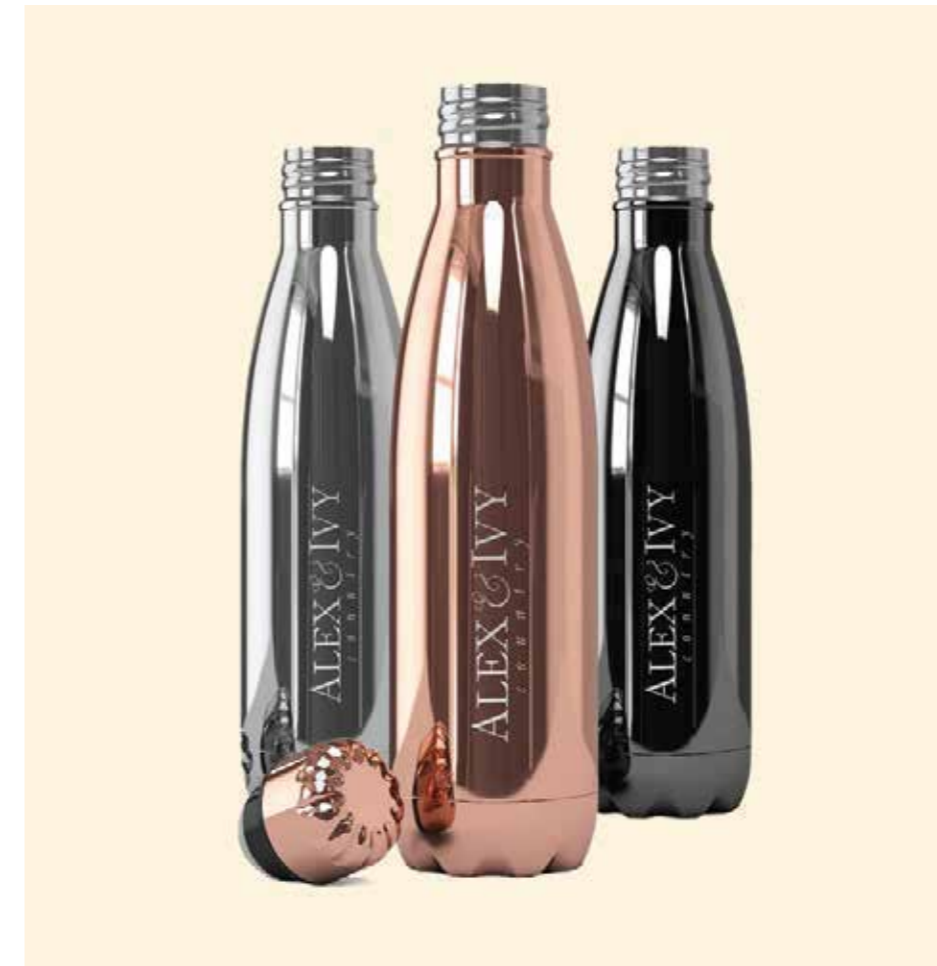

Komo Stainless Steel Drink Bottle (500ml)



Kick Eco Coffee Cup



Hi Bounce Ball



Branded Alloy Badge



Ball Pen (Twist)



Key Ring Bottle Opener



Coloured Cotton Short Handle Tote Bag



Mulan Juco Shopping Bag



Branded Gift Puppy



USB Flash Drives



Handy Highlighter



Mini Tape Measure



Handheld Retractable Banner



Neoprene Stubby Holder(T-shirt)



Car Air Freshener

Gifts & Promotions

Clothing & Apparel



Top Quality T-Shirt



Premium Quality Polo Shirts

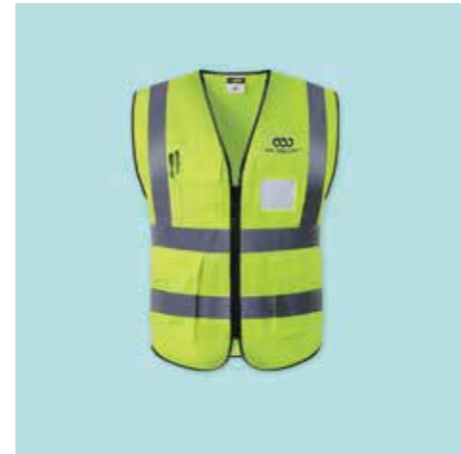

Reflective Safety Vest



Mens Stencil Hood



Unisex Scrub



Bad Waterproof Rain-defend™ Hi-vis Full-zip Fleece Hoodie



Trucker Cap



Endurance Plus Helmet



Grade Cap



Acrylic Beanie - Toque



Canvas Sun Hat



Carrie Tote



Backpack



Scarf



Gym Duffel Bag

Clothing & Apparel



1300 550 168

www.bigbanner.com.au



*All prices in this catalogue are GST EXCLUSIVE.
Prices are subject to change without notice. BBA reserves all rights for final explanation.

📍 Sydney
340 Chisholm Rd
Auburn
NSW 2144

📍 Melbourne
71 Strzelecki Ave
Sunshine West
VIC 3020

📍 Brisbane
37 Smallwood St
Underwood
QLD 4119

📍 China
Guangzhou
Shanghai
Shenzhen