



Trusted Signage Supplier

[TRADE ONLY]

PRODUCT CATALOGUE



BUSINESS SIGNAGE

LIGHTBOX & DISPLAY

EQUIPMENT & TOOLS

1300 550 168

sales@bigbanner.com.au

1 | Business Signage

P1-24



3 | Equipment & Tools

P27-30



2 | Sign Accessories

P25-26



4 | Exhibition & Display

P31-42



INFINITY



Please prepare below information when you need a quote:



Draft of design with dimensions marked, if not available, provide contents (letters, logo, font, size of space where the sign will be installed).



Interior or Exterior?



Illuminate or Non-illuminate?



Deadline if applicable



Installation Information

- (1) Where
- (2) Current condition for installation point
- (3) Distance from ground

With the above information, a quote/proposal will be provided within 12 working hours.

Business Signage



3D Signage

Acrylic Fabricated LED Channel Letters 3D-027

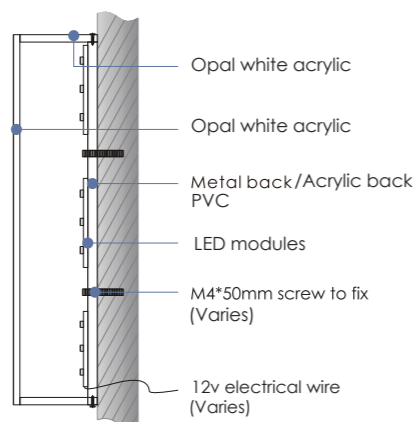

Face & Body: Acrylic fabrication/20mm opal acrylic engraved
Finish: Glue sealed, 2 pac paint on face or plain colour acrylic/stainless steel face/UV PVC
Back: Enclosed with 3mm acrylic or metal panel
Illumination: LED modules, 3,000k ~ 10,000k (Dimmer available at extra cost)
Installation: Installation template included, stand-off bolts/screws or flush mounting
Power supply: 12v-240v Meanwell transformer/C-tick Certified
Colour/Size/Shape: Customized

Back-illuminated Acrylic Letters 3D-026

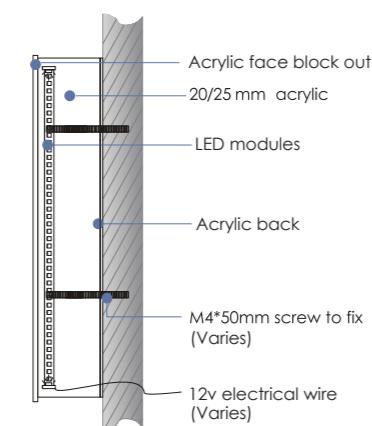

Face: 3mm solid acrylic block out with colour
Body: 3mm acrylic fabrication
Option: 25mm solid acrylic engraved
Finish: Glue sealed, 2 pac paint on face or plain colour acrylic/stainless steel face/UV PVC
Back: Enclosed with 3mm acrylic
Illumination: LED modules, 3,000k ~ 10,000k (Dimmer available at extra cost)
Installation: Installation template included, stand-off bolts/screws or flush mounting
Power supply: 12v-240v Meanwell transformer/C-tick Certified
Colour/Size/Shape: Customized

Stainless Steel Letters With LED Back Illumination 3D-1002

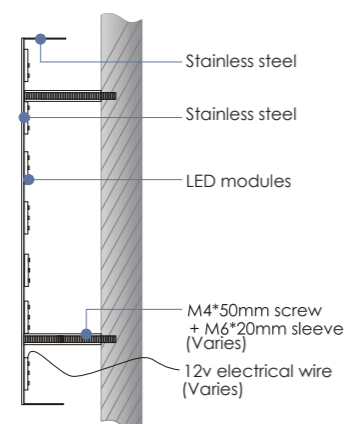

Face & Body: 1mm stainless steel (304/316 grade) fabricated
Options: Thickness 1mm/2mm/3mm, etc.
Finish: Plain silver, polished/brushed, electrical plated, powder coated, aged/rusty, UV printed, etc.
Back: Open/acrylic enclosed
Illumination: LED modules, 3,000k~10,000k (Dimmer available at extra cost)
Installation: Installation template included, stand-off bolts/screws or flush mounting
Power supply: 12v-240v Meanwell transformer/C-tick Certified
Colour/Size/Shape: Customized

Face Illuminated Rimless LED Letters 3D-007

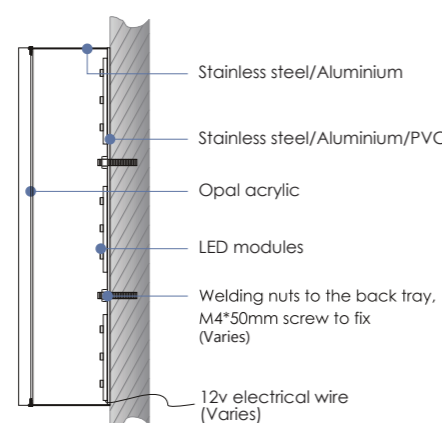

Face: 3mm / 4.5mm / 6mm Acrylic
Body: 1mm stainless steel (304/316 grade) fabricated/Aluminium
Thickness Option: 1mm / 2mm / 3mm
Finish: Plain silver, polished/ brushed, electrical plated, powder coated, digital printed, etc.
Back: Metal base /PVC backing
Illumination: LED modules, 3,000 ~ 10,000k (Dimmer available at extra cost)
Installation: Installation template included, stand-off bolts/screws or flush mounting
Power supply: 12v-240v Meanwell transformer/C-tick Certified
Colour/Size/Shape: Customized

3D Signage

Engraved Acrylic Letters with LED Illumination Mini-L

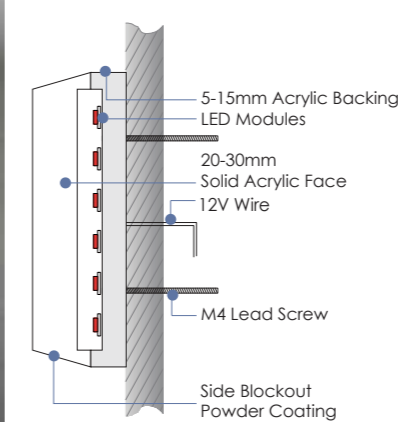

Face & Body: 25mm/20mm solid acrylic engraved
Lighting method: Face + rear side illumination, side block out (colour painted TBC)
Back: 3mm/5mm/7mm acrylic back with illumination
Illumination: LED modules, 3,000k ~ 10,000k (Dimmer available at extra cost)
Installation: Installation template included, stand-off bolts/screws or flush mounting
Power supply: 12v-240v Meanwell transformer/C-tick Certified
Colour/Size/Shape: Customized

Metal Fabricated Letters with Acrylic Base 3D-006

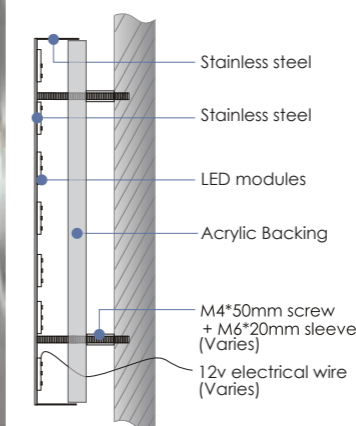

Material: 1mm stainless steel (304/316 grade) fabricated
Options: Thickness 1mm/2mm/3mm, etc.
Face: Polished mirror stainless steel
Options: brushed, aged copper, powder coated, UV, etc.
Illumination: LED modules, 3,000k ~ 10,000k (Dimmer available at extra cost)
Installation: Installation template included, stand-off bolts/screws or flush mounting
Power supply: 12v-240v Meanwell transformer/C-tick Certified
Colour/Size/Shape: Customized

Face Illuminated Channel Letter 3D-005

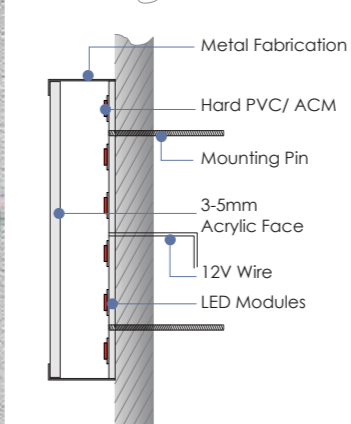

Face: 3mm / 4.5mm Acrylic
Body: 1mm 304 grade stainless steel fabricated (Option: 316 Marine Grade / Aluminium)
Finish: Plain silver, polished / brushed, electrical plated, powder coated, UV printed, etc.
Back: Metal base/PVC
Illumination: LED modules 3,000K ~10,000K (Dimmer available at extra cost)
Installation: Installation template included, stand-off bolts/screws or flush mounting
Power Supply: 12v-240v Meanwell transformer/C-tick Certified
Colour/Size/Shape: Customized

LED Bulbs Marquee Letters 3D-95

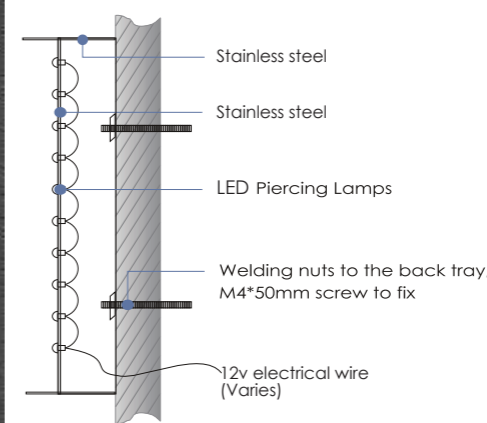
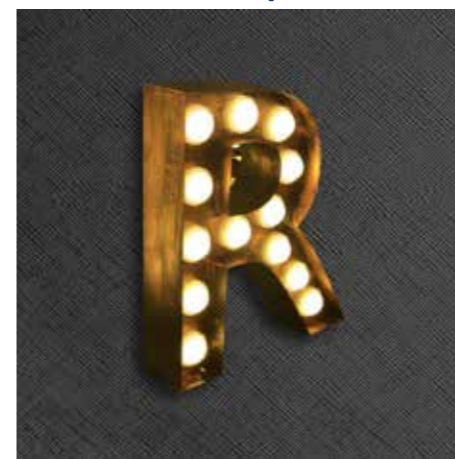

Material: 1mm stainless steel (304/316 grade) fabricated
Finish: Powder coated or Plating into metallic colour
Back: Stainless steel enclose PVC backing
Illumination: LED modules, 3,000k ~ 10,000k (Dimmer available at extra cost)
Installation: Installation template included stand-off bolts/screws or flush mounting
Power supply: 12v-240v Meanwell transformer/C-tick Certified
Colour/Size/Shape: Customized

3D Signage

Customized LED Flex Neon Sign Neon-1



Material: PVC/Rubber Tube (internal use only)
Diameter: 6mm/8mm/12mm
Installation: supplied with acrylic backing panel, metal panel, metal frame. Hanging system available by special request.
Power Supply: 12v/24v-240v Meanwell transformer/C-tick Certified
Colour/Size/Shape: Customized

Acrylic Engraved Curved LED Neon Sign Neon-3



Material: Cast Acrylic
Face & Body: 15mm-25mm solid acrylic engraved for LED module filling
Back: Metal/ABS
Finish: Face illumination, side block out (colour painted TBC)
Illumination: 6,500k LED face illuminated
Installation: installation template included, flush mounting
Power supply: 12v-240v, C-Tick Meanwell transformer
Colour/Size/Shape: Customized

Embossed Antique Brass Metal Custom-made Sign Plaques Msign-EM



- Custom-made antique brass metal emblem plaques, zinc alloy, vintage antique, brass plated metal sign board, name plates, emblem plaques
- Material and process including zinc alloy, die casting, polishing, antique brass plated
- Logo embossed with antique, vintage, gold or silver color effects.
- Customized made to your requirement.

LED Rimless Resin Letters 3D-Resin



Face: 8mm-10mm Liquid acrylic / resin
Body: 1mm 304 grade stainless steel fabricated (Option: 316 Marine Grade)
Back: Metal base
Finish: Plain silver, polished / brushed, electrical plated
Illumination: LED modules, 3,000k ~ 10,000k (Dimmer available at extra cost)
Installation: Installation template included, stand-off bolts/screws or flush mounting
Power supply: 12v-240v Meanwell transformer/C-tick Certified
Colour/Size/Shape: Customized

3D Signage

Stainless Steel Channel Letters 3D-001



Face & Body: 1mm stainless steel (304/316 grade) fabricated
Options: Thickness 1mm/2mm/3mm, etc.
Finish: Plain silver, polished/brushed, electrical plated, powder coated, aged/rusty, UV printed, etc.
Back: Open/PVC Backing
Illumination: N/A
Installation: Installation template included, stand-off bolts/screws or flush mounting.
Colour/Size/Shape: Customized

Flat Cut Letters SS-S2



Face & Body: 1mm, 2mm, 3mm... 6mm, etc. Aluminum, Iron, Brass, Copper, Stainless Steel, etc. 304/316 grade stainless steel
Illumination: N/A
Installation: Installation template included, stand-off bolts/screws or flush mounting.
Colour/Size/Shape: Customized

Cylinder 3D Metal Letters 3D-CYLINDER



Materials & Finishes: Aluminum/Brass - 2pac painting, powder coated, oxidised
Face & Body: 3/5/8/10/15/20/25/30mm
Illumination: N/A
Installation: Installation template included, stand-off bolts/screws or flush mounting.
Colour/Size/Shape: Customized

Acrylic Routed Letters 3D-098

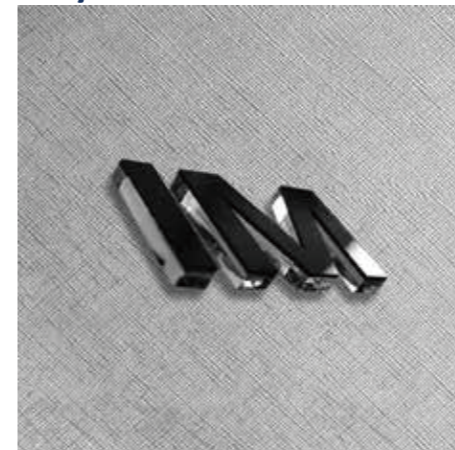

Face & Body: 3mm ~ 25mm acrylic routed/laser cut
Finish: UV print/2 Pac paint/Plain colour
Illumination: N/A
Installation: Installation template included, stand-off bolts/screws or flush mounting
Colour/Size/Shape: Customized

3D Signage

Infinite Mirror Effect 3D LED Neon Sign 3D-Infinite-Sign



Face: Mirror/stalinite with illuminated neon or acrylic letter face
Body: 1mm 304 grade stainless steel fabricated returns with reflective mirror + light transmitting mirror inside to create infinite effect
Finish: Plain silver, polished / brushed, electrical plated, powder coated, 2 pac painted etc
Back: Acrylic/Aluminium
Illumination: LED modules 3,000K ~10,000K (Dimmer available at extra cost)
Installation: Installation template included, stand-off bolts/screws or flush mounting.

Push Through Style LED Light Box LB-PT



Customizable: Allows for a wide range of custom designs, including different fonts, sizes, and styles of letters or graphics.
Durability: The use of durable materials and LED lighting ensures long-lasting performance
Even Illumination: Ensures even light distribution across the letters or graphics, reducing hot spots and creating a consistent, visually pleasing effect
Energy Efficiency: Use LED lighting, which is energy-efficient and has a long lifespan
Easy Maintenance: Can be easily replaced or updated without the need to disassemble the entire light box

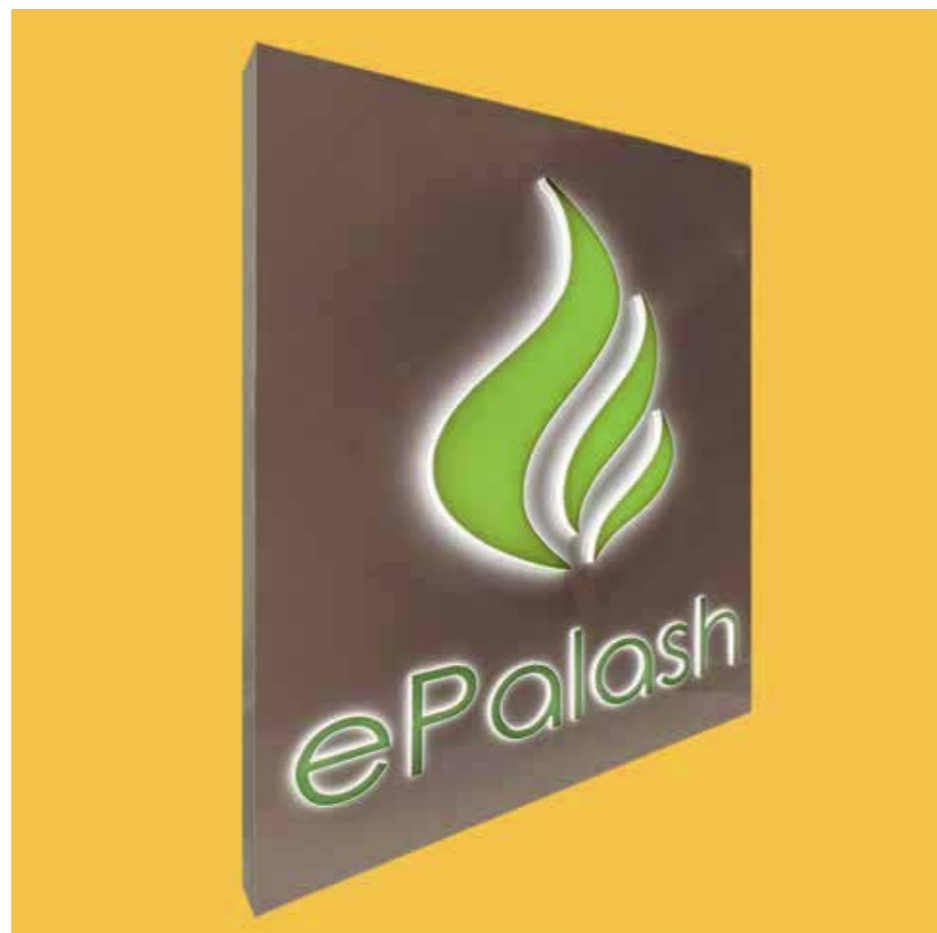

Metal Signage

Aluminum Composite Panel Sign Msign-01



Size	Price
600 x 900mm	\$90
900 x 1200mm	\$150
1200 x 1500mm	\$250
2440 x 1220mm	\$340
3050 x 1500mm	\$520

Customized sizes available

Real Estate For Sale | For Lease Sign Board | Ready To Go Sign Msign-R-1

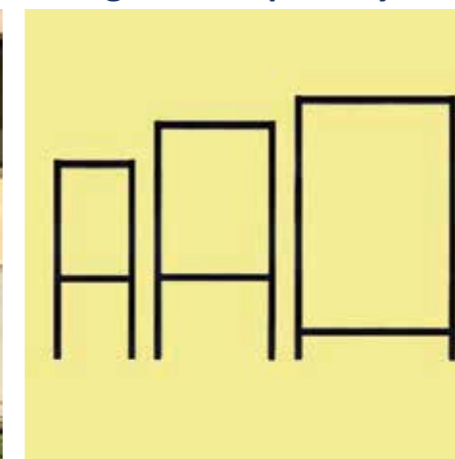

Star Pickets/Free Standing Feet

Size	Overall Height	Single Side Print	Double Side Print
600 x 900mm	1500mmH	\$240	\$360
900 x 1200mm	1800mmH	\$360	\$490
1200 x 1800mm	2000mmH	\$480	\$690

- Created in pieces, simple to assemble and easy to transport.
- Made of powder coated 50mm square steel tube
- Ideal for outdoor signage, such as real estate, cafes and restaurants, local stores, councils (public areas).
- Base options: Spikes/Star Pickets \$50; Free Standing Feet \$60.

Metal Signage

ACM Fabricated Sign Boxes

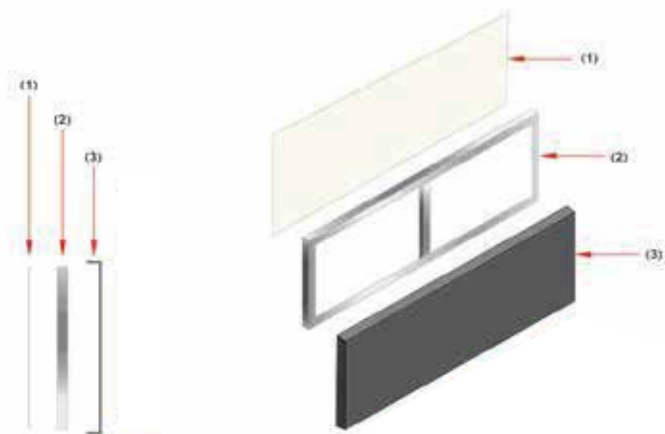

- Aluminium frame wrapped with composite panel
- Folded on edges with v-groove cut.
- Screws on the return with no visible fixing on face
- Full colour print or raised logo on the face
- Great choice for illuminated signs which allows wires to run inside.

Routed Aluminium Signs

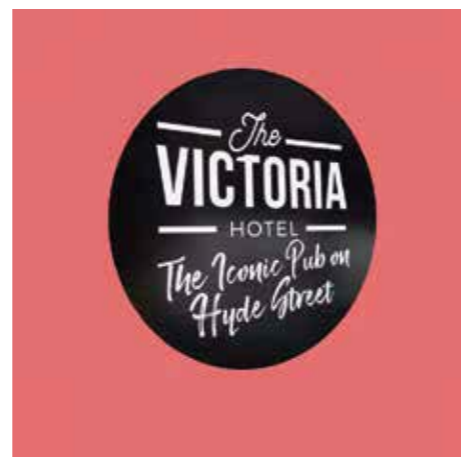

- Custom-made by CNC router
- 3mm thickness sturdy aluminum composite metal sheet
- High resolution printed vinyl or 3D signs mounted on panel
- Weather tolerant & UV resistant
- Great for outdoor or indoor use
- Full panel size available in 1220x2440mm from \$360 each panel
- Extra cost applied for designs with more details

Panel Size	Price
1200 x 800mm	\$150
1200 x 1200mm	\$240
1200 x 1800mm	\$300

Acrylic Signs

Acrylic Panel – Sign Board AS-002



- wall, frameless with a sharp look
- Suitable for all types of images such as wedding photos, family or single portraits, etc.
- Made from quality acrylic panels
- Come with aluminum standoffs for
- Customized sizes available
- 6mm, 10mm

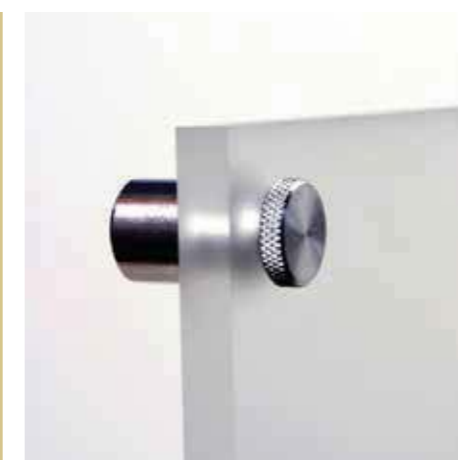

Size	Thickness	Price
600 x 800mm	4.5mm	\$285
600 x 1200mm	4.5mm	\$385
900 x 1500mm	4.5mm	\$589
600 x 800mm	6.0mm	\$349
600 x 1200mm	6.0mm	\$439
900 x 1500mm	6.0mm	\$689

Please contact us for size or thickness not listed above.

Acrylic Light Box Panel AS-LB



- UV and water resistant suitable for outdoor use
- changing image, etc.
- Customized sizes available to suit
- 6mm

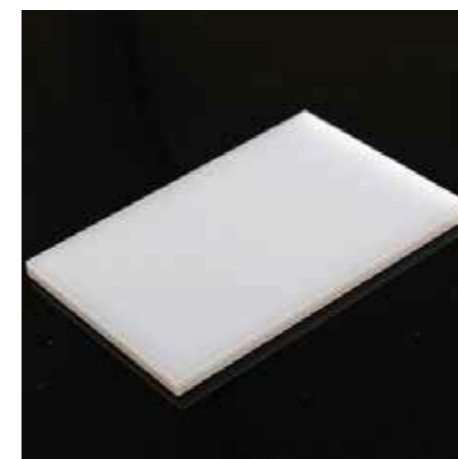

Size	Thickness	Price
400 x 1200mm	3.0mm	\$120
400 x 1800mm	3.0mm	\$150
600 x 2000mm	3.0mm	\$220
600 x 2440mm	3.0mm	\$240
400 x 1200mm	4.5mm	\$150
400 x 1800mm	4.5mm	\$200
600 x 2000mm	4.5mm	\$260
600 x 2440mm	4.5mm	\$300

Please contact us for size or thickness not listed above.

Single-sided LED Light Box Square

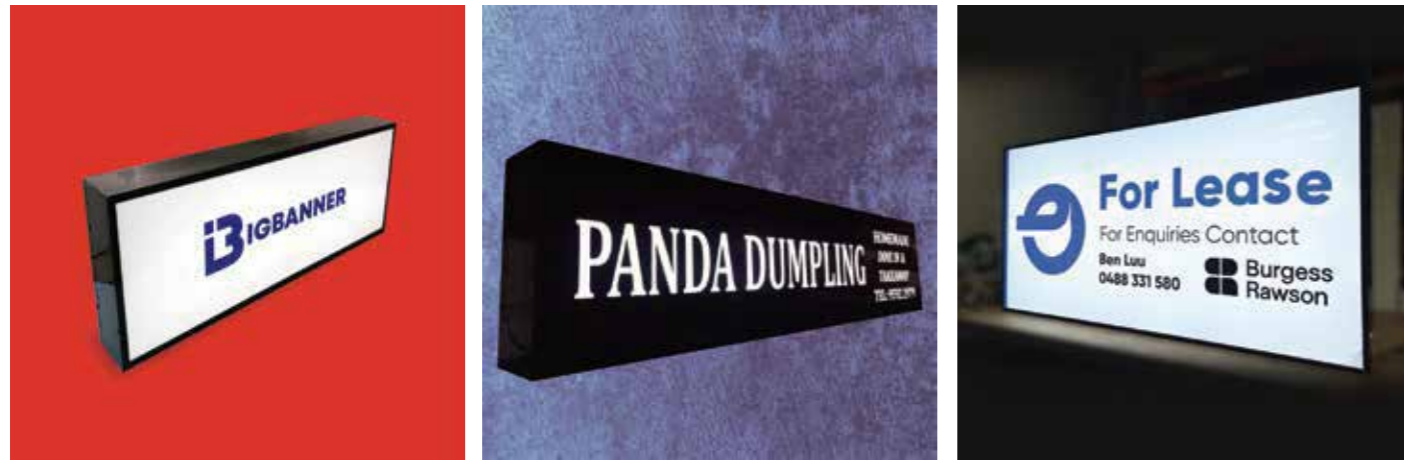

LB-SS-S

LB-SS-L

LB-SS

LB-SS-S Size	Hardware Only	With Printing	LB-SS-L Size	Hardware Only	With Printing
500 x 400mm	\$360	\$440	1200 x 400mm	\$445	\$525
500 x 500mm	\$365	\$445	1200 x 500mm	\$470	\$550
600 x 400mm	\$365	\$445	1200 x 600mm	\$495	\$575
600 x 500mm	\$380	\$460	1200 x 700mm	\$520	\$600
600 x 600mm	\$395	\$475	1200 x 800mm	\$600	\$680
700 x 400mm	\$375	\$455	1200 x 1200mm	\$700	\$800
700 x 500mm	\$395	\$475	1500 x 400mm	\$540	\$620
700 x 600mm	\$415	\$495	1500 x 500mm	\$570	\$650
700 x 700mm	\$430	\$510	1500 x 600mm	\$605	\$685
800 x 400mm	\$390	\$470	1500 x 700mm	\$635	\$735
800 x 500mm	\$410	\$490	1500 x 800mm	\$755	\$855
800 x 600mm	\$430	\$510	1800 x 400mm	\$585	\$665
800 x 700mm	\$450	\$530	1800 x 500mm	\$620	\$700
800 x 800mm	\$520	\$600	1800 x 600mm	\$660	\$760
900 x 400mm	\$405	\$485	1800 x 700mm	\$695	\$795
900 x 500mm	\$425	\$505	1800 x 800mm	\$820	\$920
900 x 600mm	\$445	\$525	2000 x 400mm	\$785	\$865
900 x 700mm	\$465	\$545	2000 x 500mm	\$825	\$905
900 x 800mm	\$540	\$620	2000 x 600mm	\$865	\$965
900 x 900mm	\$560	\$640	2000 x 700mm	\$905	\$1005
1000 x 400mm	\$415	\$495	2000 x 800mm	\$1040	\$1160
1000 x 500mm	\$440	\$520	2200 x 400mm	\$815	\$895
1000 x 600mm	\$460	\$540	2200 x 500mm	\$855	\$955
1000 x 700mm	\$485	\$565	2200 x 600mm	\$900	\$1000
1000 x 800mm	\$560	\$640	2400 x 400mm	\$845	\$925
1000 x 900mm	\$580	\$660	2400 x 500mm	\$890	\$990
1000 x 1000mm	\$605	\$685	2400 x 600mm	\$935	\$1035

Aluminium fabricated frame with black powder coating (customized colour at extra cost)

150mm depth box frame | LED lighting source | 3mm/4.5mm opal acrylic face panel | Hanging bracket

Package Option:

Accessory Option:

Bubble wrap (for pickup)	Free	1.2m hanging bar black/pair (30x30)	\$135+gst
Carton box (<500x2400mm)	\$100+gst	1.2m hanging bar black/pair (40x40)	\$160+gst
Pallet (>500x2400mm)	\$200+gst	160mm side wall bracket black/pair	\$135+gst
Pallet (>1500x3000mm)	\$350+gst		
or mutiple qty			

Double-sided LED Light Box Square



LB-SQ

LB-SQ

LB-SQ Size	Hardware Only	With Printing	With Bracket
400 x 400 x 150mmD	\$360	\$440	\$575
400 x 600 x 150mmD	\$375	\$455	\$590
500 x 500 x 150mmD	\$370	\$450	\$585
600 x 600 x 150mmD	\$395	\$495	\$630
700 x 700 x 150mmD	\$490	\$590	\$725
600 x 800 x 150mmD	\$435	\$535	\$670
800 x 800 x 150mmD	\$530	\$650	\$785
1000 x 1000 x 150mmD	\$620	\$760	\$895

- **Frames:** 150mm deep extruded aluminium frame, double-sided, powder coated in black.
- **Face:** 3mm/4.5mm thick opal acrylic panels on both sides.
- **Light source:** Side-lighting LEDs.
- Waterproof and UV resistant, indoor and outdoor use.
- Flush mount on the wall or with wall brackets (optional).



HB3030 | HB4040



WB-160



LB-DS-S

LB-DS-L

LB-DS Size	Hardware Only	With Printing	With Bracket
500 x 400mm	\$360	\$440	\$475
800 x 400mm	\$405	\$505	\$640
1000 x 400mm	\$435	\$535	\$670
1200 x 400mm	\$470	\$570	\$705
1500 x 400mm	\$570	\$690	\$825
1800 x 400mm	\$625	\$745	\$880
2000 x 400mm	\$830	\$970	\$1105
2200 x 400mm	\$865	\$1005	\$1140
2200 x 500mm	\$895	\$1065	\$1200
2400 x 400mm	\$900	\$1040	\$1175
2400 x 500mm	\$935	\$1105	\$1240
2400 x 600mm	\$970	\$1180	\$1315



- **Frame:** 150mm deep extruded aluminium frame. Powder coated in black.
- **Face:** 3mm/4.5mm thick opal acrylic panels on both sides.
- **Light source:** Bright white side-lighting LED modules, bright and even illumination.
- Waterproof and UV resistant, indoor and outdoor use.

Aluminium fabricated frame with black powder coating (customized colour at extra cost)

150mm depth box frame | LED lighting source | 3mm/4.5mm opal acrylic face panel | Hanging bracket 1.2m at \$135/ pair

Round Light Box

Single-Sided Aluminum Light Box LB-RD-FLAT-S

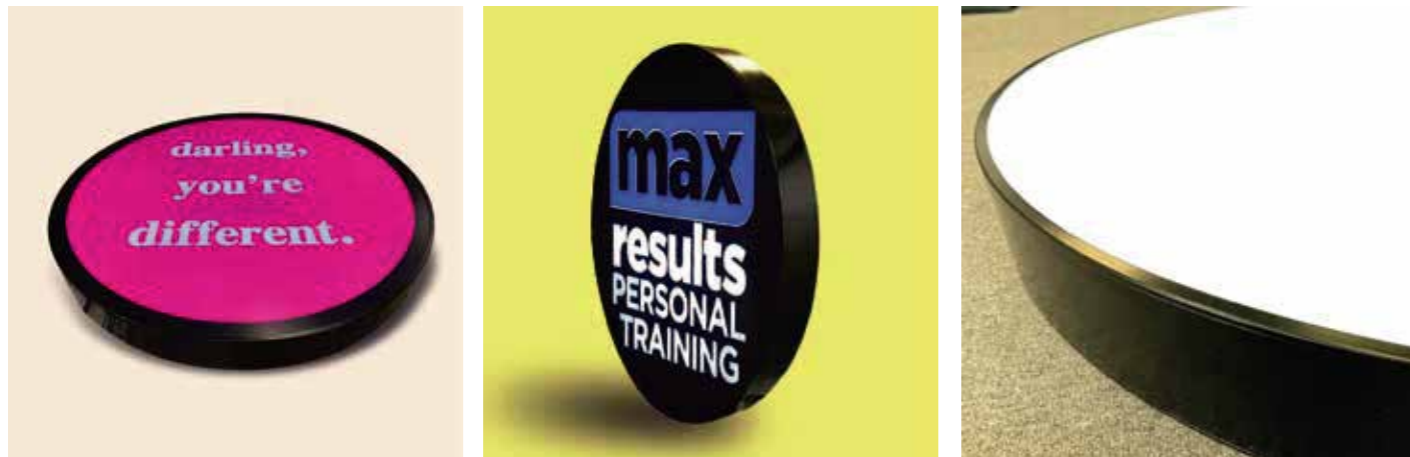

Size	Hardware Only	With Printing
500mmD	\$430	\$510
600mmD	\$460	\$570
700mmD	\$530	\$640
800mmD	\$620	\$750
1000mmD	\$875	\$1040
1200mmD	\$1380	\$1520

- **Frames:** Extruded aluminium with black powder coating
- **Face:** 3mm/4.5mm thick flat opal acrylic face
- **Light source:** Side-lighting LEDs, cool white
- Exterior and interior use
- Comes with wall mounting angle bracket ready to be fitted on to wall, plug and play

Double-Sided Aluminum Blade Sign – Vacuum Formed Face LB-RV

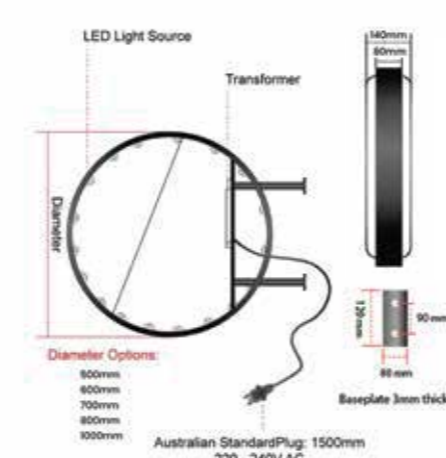
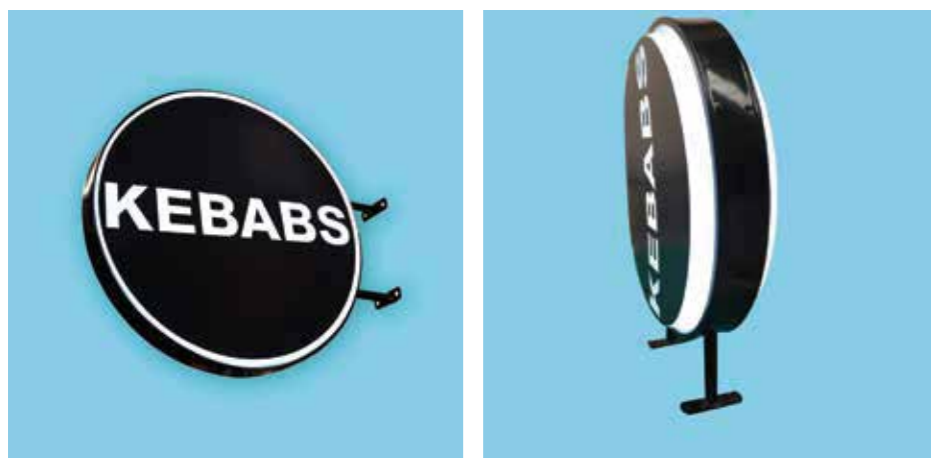

Size	Hardware Only	With Printing
500mmD	\$550	\$650
600mmD	\$560	\$710
700mmD	\$575	\$750
800mmD	\$630	\$840

- **Frames:** Extruded aluminium with black powder coating
- **Face:** 3mm thick vacuum foamed opal acrylic face, double-sided
- **Light source:** Side-lighting LEDs, cool white
- Exterior and interior use
- Comes with brackets ready to be fitted on to wall or ceiling, plug and play

Round Light Box

Double-Sided Aluminum Blade Sign | Single Post LB-RD-SP



Size	Hardware Only	With Printing
500mmD	\$525	\$675
600mmD	\$575	\$740
700mmD	\$630	\$815
800mmD	\$720	\$925
1000mmD	\$990	\$1165

- **Frames:** Extruded aluminium with black powder coating.
- **Face:** 3mm/4.5mm thick flat opal acrylic face, double-sided
- **Light source:** Side-lighting LEDs, cool white
- Exterior and interior use
- Come with single post ready to be fitted on to wall or ceiling, plug and play

Double-Sided Aluminum Blade Sign | Circle Light Box LB-RD-FLAT



Size	Hardware Only	With Printing
500mmD	\$540	\$690
600mmD	\$575	\$740
700mmD	\$630	\$815
800mmD	\$720	\$925
1000mmD	\$990	\$1165
1200mmD	\$1400	\$1630

- **Frames:** Extruded aluminium with black powder coating
- **Face:** 3mm/4.5mm thick flat opal acrylic
- **Light source:** Side-lighting LEDs, cool white
- Exterior and interior use
- Come with brackets ready to be fitted on to wall or ceiling, plug and play

Round Light Box

Acrylic Fabricated LED Circle Light Box LACYLB-R

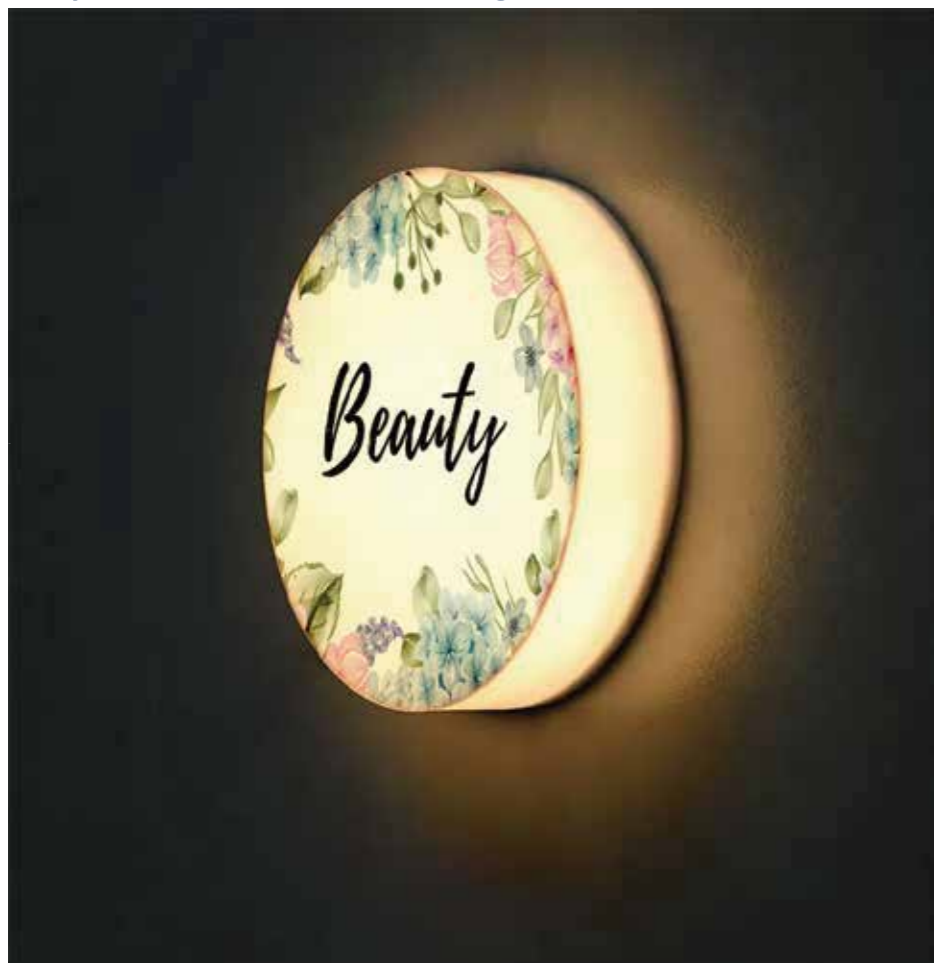

Size	Hardware Only	With Printing
500mmD	\$595	\$655
600mmD	\$650	\$720
700mmD	\$710	\$790
800mmD	\$780	\$870
1000mmD	\$930	\$1040
1200mmD	\$1100	\$1220

- Opal acrylic fabricated light box (3mm 4.5mm acrylic panel as per demand)
- LED modules 12V/240V, 6500K fixed on back panel (Optional 3000k, 6500k & 10000k)
- Colour LED available with extra cost Full colour print graphic or cut out vinyl graphic applied on surface
- Bright and Even Illumination (Face and Side)
- Exterior and interior use
- Standard thickness (return): 100mm

Luminated Lollipop Signs Lollipop Sign



- **Size:** 340mm in diameter double side printed light box
- **Approx Weight:** 700gms including the monopole and battery
- **Frame Colours:** Aluminum/silver
- **Monopole:** 60cm standard

Lollipop Sign	Price
1 Unit	\$490
2 Units	\$590
3 Units	\$790
4 Units	\$990

Round Light Box

Acrylic Fabricated LED Cube Light Boxes ACYLB-SQ



Size	Hardware Only	With Printing
500 x 300 x 300mm	\$595	\$695
500 x 500 x 500mm	\$795	\$945
600 x 600 x 600mm	\$895	\$1045
700 x 700 x 700mm	\$1045	\$1195
800 x 200 x 200mm	\$745	\$945
1000 x 300 x 300mm	\$945	\$1145
1200 x 300 x 300mm	\$1045	\$1265
1500 x 300 x 300mm	\$1295	\$1535

- Opal acrylic fabricated light box (3mm 4.5mm 6mm acrylic panel as per demand)
- LED modules 12V/240V, 6500K fixed on back panel (Optional 3000k, 6500k & 10000k)
- Colour LED available with extra
- Full colour print graphic or cut out vinyl graphic applied on surface
- 5 sides illumination
- Exterior and interior use

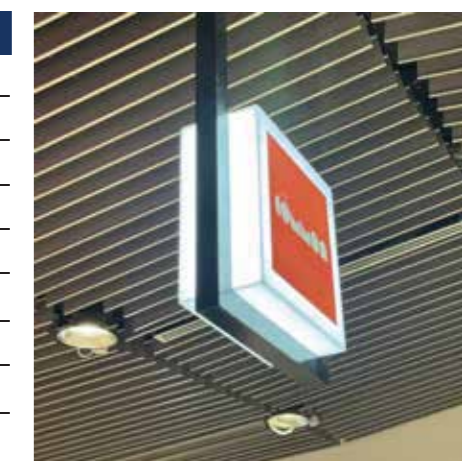

LED Window Signs



Real Estate Window Display LED Lightbox A3 size | LED Window Signs

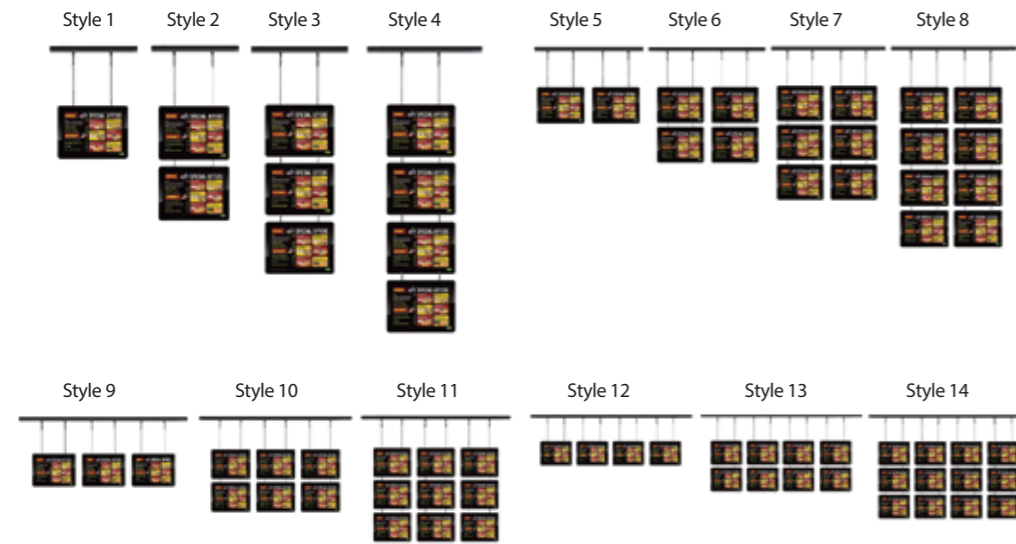

Style	Price
Style 1	\$210
Style 2	\$345
Style 3	\$465
Style 4	\$600
Style 5	\$375
Style 6	\$590
Style 7	\$880
Style 8	\$1145
Style 9	\$580
Style 10	\$980
Style 11	\$1400
Style 12	\$765
Style 13	\$1310
Style 14	\$1850

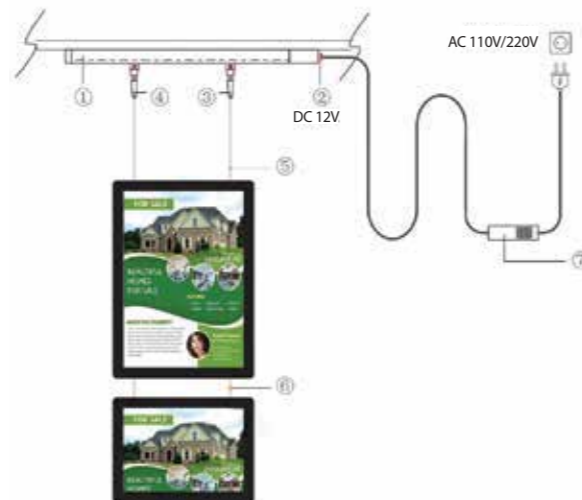

- Package Includes:**
- Ceiling Rail Tack
 - DC Plug
 - Positive Standoff
 - Negative Standoff
 - Ceiling Stainless Steel Cables
 - 45mm Mini Joiners
 - Transformer

LED Window Signs



Real Estate Window Display LED Lightbox A4 size | LED Window Signs

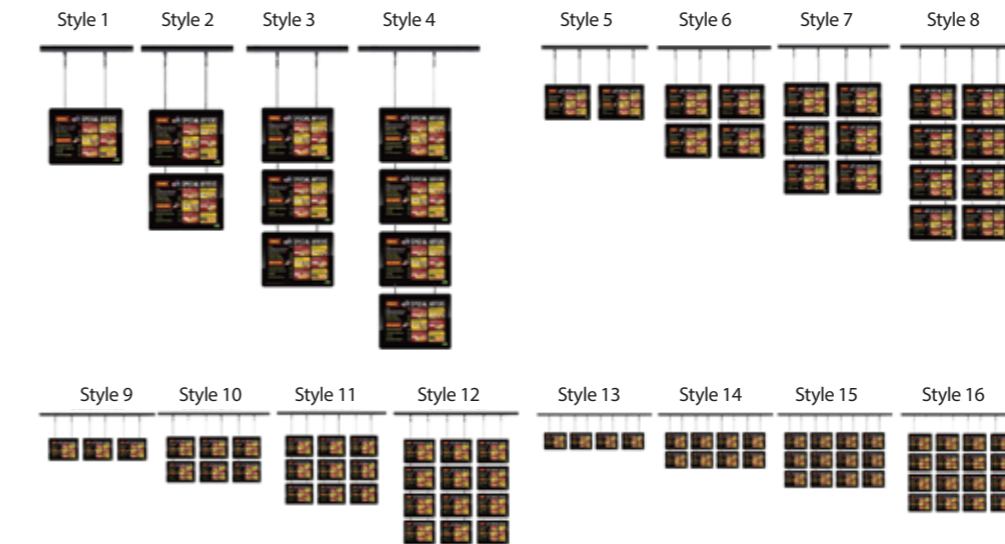

Style	Price
Style 1	\$200
Style 2	\$295
Style 3	\$395
Style 4	\$485
Style 5	\$315
Style 6	\$525
Style 7	\$700
Style 8	\$895
Style 9	\$495
Style 10	\$775
Style 11	\$1080
Style 12	\$1350
Style 13	\$590
Style 14	\$980
Style 15	\$1395
Style 16	\$1795

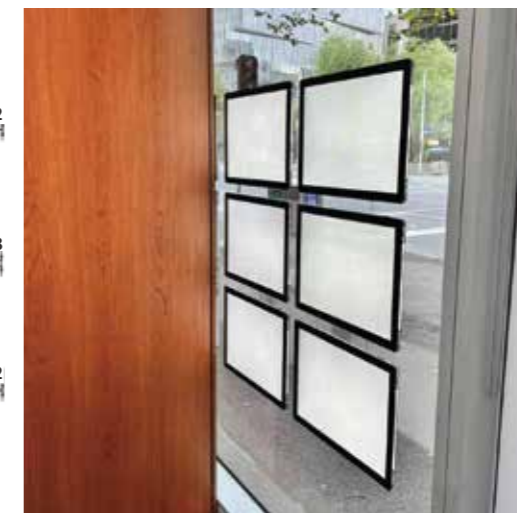
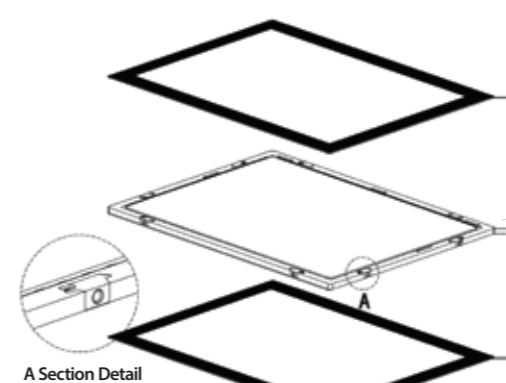

- Package Includes:**
- Ceiling Rail Tack
 - DC Plug
 - Positive Standoff
 - Negative Standoff
 - Ceiling Stainless Steel Cables
 - 45mm Mini Joiners
 - Transformer

Light Box

Fabric Light Box FLB-01

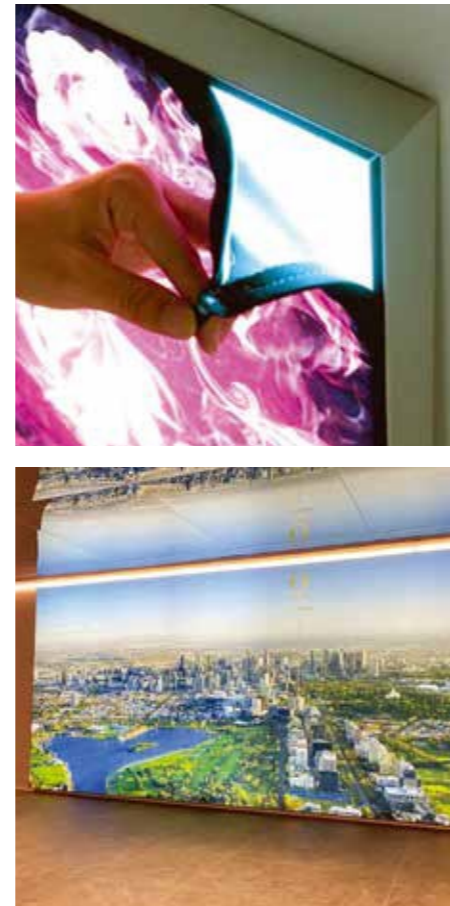

Size	Depth	Price
900 x 1200mm	80mmD	\$650
850 x 2000mm	80mmD	\$850
900 x 2400mm	80mmD	\$950
1000 x 3000mm	80mmD	\$1500
2000 x 2000mm	80mmD	\$1650
2000 x 3000mm	80mmD	\$2400
2000 x 4000mm	80mmD	\$3600
2300 x 6000mm	80mmD	\$4800

- Graphics printed for the frameless light box provide a rich & vibrant color quality that is second to none.
- Frameless light box is made from lightweight recycled aluminum. It is very easy to dismantle and can be done in just a few minutes, which makes it great for trade shows, events or relocating. Despite their large display size, they can be stored in very small spaces.

Assemble instruction

1. Take out all parts. 2. Assemble the corner. 3. Screw tight the back corner.

4. Install on the wall by screws through the screw holes. 5. Install the LED lights. 6. Install the transformer.

7. Connect the LED lights & transformer to the main electric circuit. 8. Install the poster. 9. Finish the installation.

Transformer connection

Please contact us for sizes not listed above

Light Box

Free-Standing Double-sided LED Light Box FLB-01

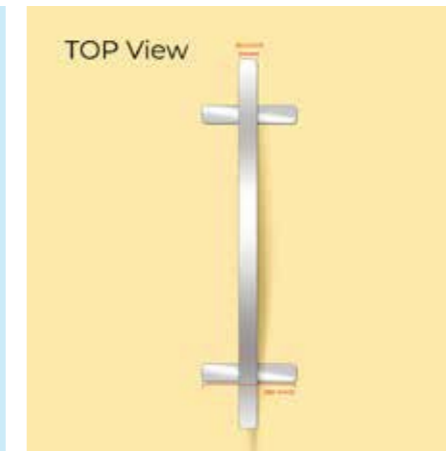

Size	Depth	Single Side Print	Double Side Print
850 x 2000mmH	80mmD	\$800	\$900
1000 x 2000mmH	80mmD	\$850	\$950
1000 x 2400mmH	80mmD	\$1060	\$1250
1200 x 2400mmH	120mmD	\$1295	\$1495
2000 x 2400mmH	120mmD	\$1890	\$2150
2400 x 2400mmH	120mmD	\$2190	\$2580
3000 x 2400mmH	120mmD	\$2550	\$1980
4000 x 2400mmH	120mmD	\$3350	\$3790

The listed prices do not include carry bag. Carry bag costs \$120+gst each.

- Made of aluminum frame, Led strips, silicone seal
- Fast installation and dismantle, professional UV printing
- Premium grade backlit-fabric material
- Easily replaceable graphics
- Base size: 380x80mm
- High end green product, reusable for many times
- Suitable for all kinds of shopping mall and other advertisement use

Single Side Fabric Light Box | Large Round Light Box FLB-R-SS

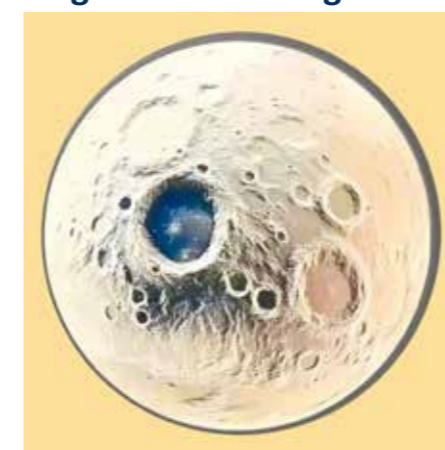

Size	Price
800mm	\$650
900mm	\$650
1000mm	\$750
1200mm	\$950
1500mm	\$1250
1800mm	\$1750
2000mm	\$1950
2400mm	\$2480
3000mm	\$3550

Graphics printed for the frameless light box provide a rich, vibrant colour quality that is second to none.

- **Smooth Edge-less Appearance**
The edge-less (frameless) look is achieved by using fabric which is sewn along the edges with a silicone beading. The graphic is stretched slightly over the extrusion where the silicon beading fits into a channel groove along the outer edge of the display.
- **Portable**
Frameless light boxes are made from lightweight recycled aluminium. It is very easy to dismantle and can be done in just a few minutes, which makes it great for trade shows, events or relocating. Despite their large display size, they can be stored in very small spaces.



MLB-22

22.8mm Magnetic Light Box

- Open with suction cup
- Quality LED light source
- **Thickness:** 22.8mm
- Acrylic face front attached to aluminium frame with magnet
- **Colour:** silver or black
- **Available sizes:** A0, A1, A2, A3 (Customized sizes available)

Size	Price
A3	\$195
A2	\$265
A1	\$375
A0	\$650

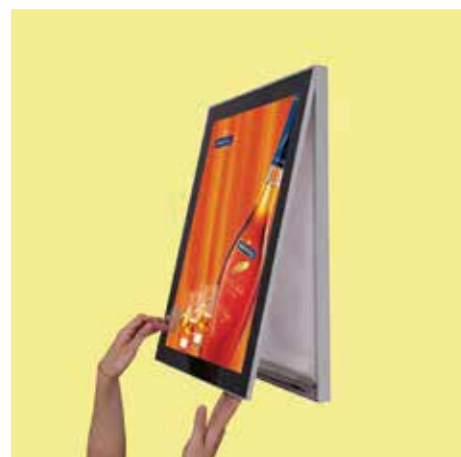

LB-M-A2

Ultra Slim Magnetic Light Box

- Quality LED light source
- **Thickness:** 10mm
- Acrylic face front attached to aluminium frame with magnet
- **Colour:** silver or black
- **Available sizes:** A1, A2, A3, (Customized sizes available)

Size	Price
A3	\$139
A2	\$175
A1	\$285



MLB-10

Ultra Slim Magnetic Light Box

- Quality LED light source
- **Thickness:** 10mm
- Acrylic face front attached to aluminium frame with magnet
- **Colour:** Silver/Black (Custom colours is doable : gold , red, white, etc)
- **Available sizes:** A1, A2, A3,A0 (Customized sizes available)

Size	Price
A3	\$139
A2	\$175
A1	\$285
A0	\$515



LB-OD

Outdoor Light Box With Locker

- Quality LED source
- Outdoor use
- Hinged swing door with lock
- Genuine SAA approved power adapter
- Portrait & Landscape display (Customized sizes available)

Size	Price
A1	\$595
A0	\$950

A4 LED Counter Top Banner Stand LBA4-Counter Top

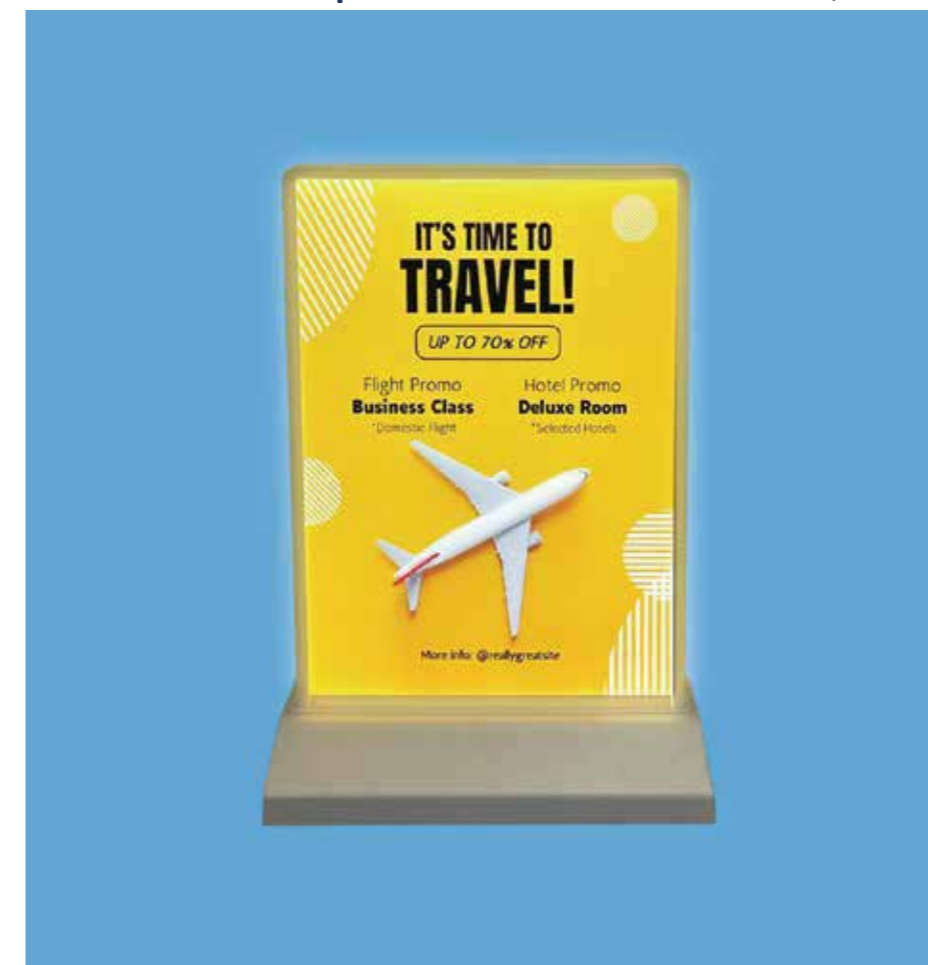

- Desk Stand Light Box
- Double Sided
- Built-in battery, it can be charged by the power bank via USB port, convenient to use
- Lithium battery, 5V, 2A, 5W. Capacity: 10,000mah

Print Options	Price
Non Printed	\$90
Double Sided Printing	\$135
Single Sided Printing	\$125
Print Only_4pcs	\$80

Outdoor LED A-Frame with Magnetic Light Box A6090-LED



- Durable, portable and user friendly
- Powder coated black frame to keep rust free
- Easy change of graphics
- Clear acrylic panel with strong magnet front panel holder
- Even light dispersion. Luminance emitted is 2000lux +/-5%. Provide best-illuminated outcome for your poster.
- Low Maintenance Cost

Price From \$295

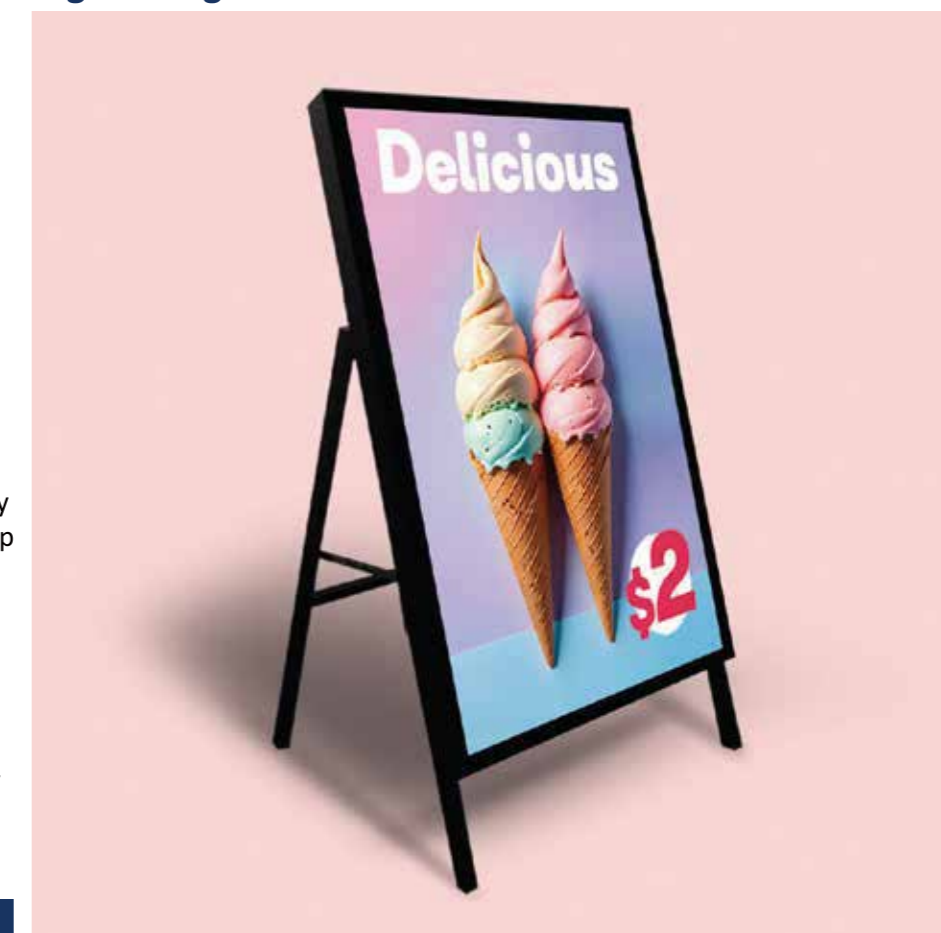

Advertising LED Logo Projector

Premium Outdoor Large Industrial Waterproof LED Projector LOPRO-L



Wattage Rating Option	Price
300W	\$1650
600W	\$2250
1200W	\$4680

Projection Distance: (dark environment)
 300W projector: within 30 meters
 600W projector: within 50 meters
 1200W projector: within 100 meters

Advertising LED Logo Projector LOPRO



Wattage Rating Option	Price
15W	\$380
35W	\$450
50W Indoor Use	\$550
50W Outdoor Use Water Proof	\$600
80W Outdoor Use Water Proof	\$750
100W Outdoor Use Water Proof	\$900
200W Outdoor Use Water Proof	\$1350

- Your logo, image or text can be projected onto wall, ground or other surfaces.
- Includes mounting bracket for easy wall or ceiling installation.

Projection Distance (dark environment):

- 15W projector: within 3 meters
- 35W projector: within 5 meters
- 50W projector: within 8 meters
- 80W projector: within 10 meters
- 100W projector: within 12 meters
- 200W projector: within 20 meters

* >50W is suitable for interior daytime use
 * choose higher wattage if the environment is bright.

Flexface Vinyl Banner Light Box



OFLB-01-2

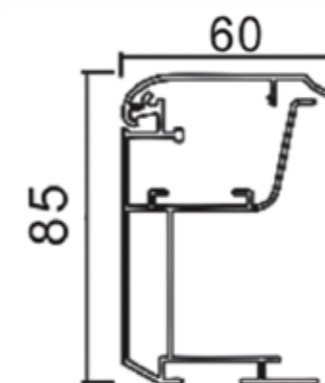
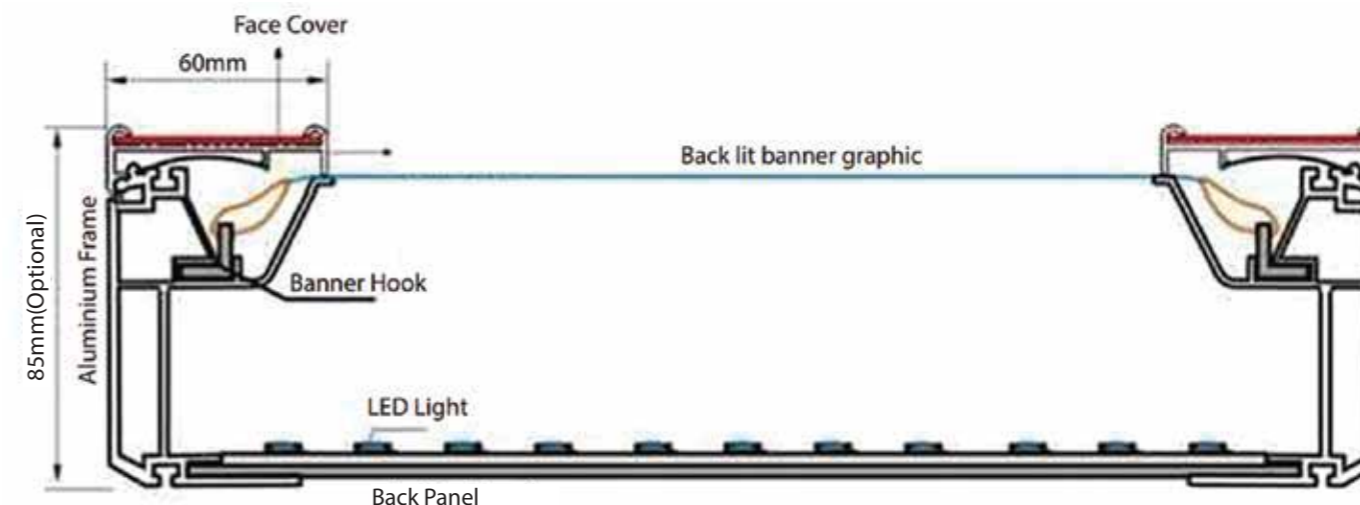

- Aluminum Frame LED light box, known as flex face light box, suitable for outdoor back-lit vinyl banner, can be assembled easily in house or on site for installation.
- Minimum package size compare to traditional light box. Cost effective and easy to handle.
- Great choice for large scale light boxes over 3 meters.

Size	Price
800 x 4000 x 85mmD	\$2250
1300 x 3500 x 85mmD	\$2580
1500 x 3000 x 85mmD	\$2650
2000 x 4000 x 85mmD	\$4450

LED Scrolling Signs

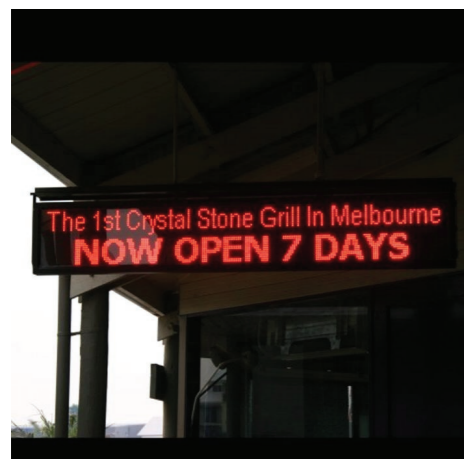

LED-CP8

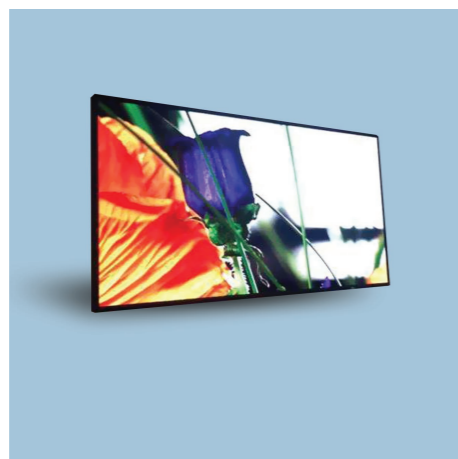

LED-C5



LED-C5

10mm/5mm PITCH Full Colour LED Sign

Display Area	Frame Size	5mm Pitch	10mm Pitch
960 x 320mm	1010 x 370mm	\$1200	\$1080
960 x 480mm	1010 x 530mm	\$1800	\$1620
960 x 640mm	1010 x 690mm	\$2250	\$2160
1280 x 320mm	1330 x 370mm	\$1500	\$1440
1280 x 480mm	1330 x 530mm	\$2300	\$2160
1280 x 640mm	1330 x 690mm	\$2800	\$2680
1280 x 800mm	1330 x 850mm	\$3400	-
1600 x 320mm	1650 x 370mm	\$1850	\$1800
1600 x 480mm	1650 x 530mm	\$2700	\$2650
1600 x 640mm	1650 x 690mm	\$3400	\$2950
1920 x 320mm	1970 x 370mm	\$2150	\$1950
1920 x 480mm	1970 x 530mm	\$3050	\$2650
2240 x 320mm	2290 x 370mm	\$2550	\$2250
2240 x 480mm	2290 x 530mm	\$3750	-
2560 x 480mm	2610 x 530mm	-	\$3400

Price of the LED modules may change, please contact for updated prices

- Customized size available
- Perfect for displaying videos, supporting most popular file formats, including AVI, WMV, RMVB, MOV, MP4, MPG, FLV, SWF, VOB, etc.
- Eye catching solution for advertising
- Suitable for both indoor and outdoor use
- Can be programmed easily by mobile or computer through WIFI
- High brightness adjustable



LCD Menu Board

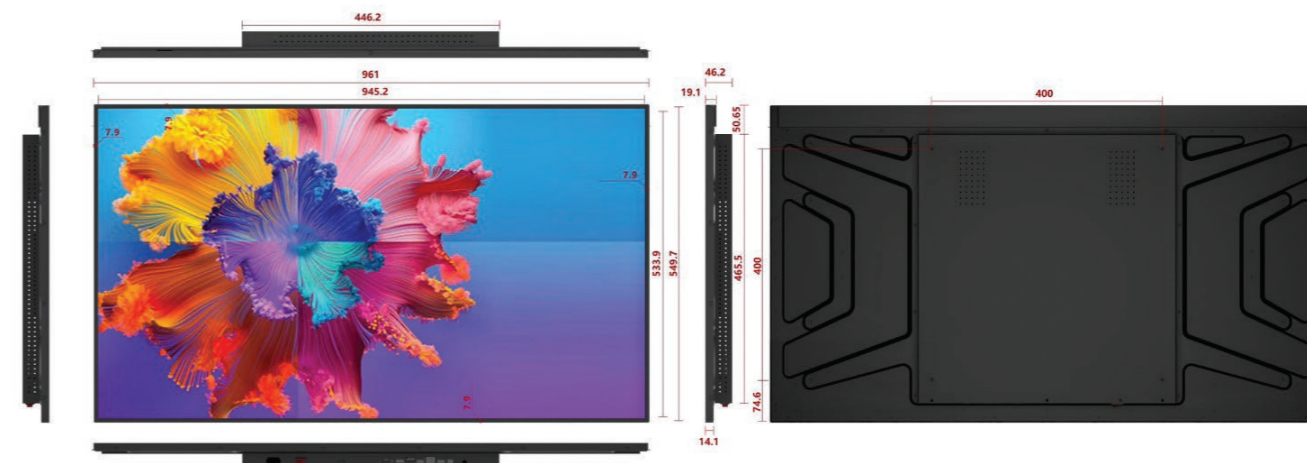

Commercial Advertising LCD Device

Specifications: 43 inch

- **Screen**
Full Size: 1006x601xmm
Display Size: 939x527mm
LCD Manufacturer: Samsung/LG/BOE
Resolution: 1920x1080
Aspect Ratio: 16 : 9
Brightness(nits): 500
Contrast Ratio: 6000 : 1
Viewing Angle: 178 / 178
Life Span: 65000 hours
Certificate: CE, FCC
- **Control System**
System: Android 9.0 + Cloud Based Remote Control system
CPU: RK3288
RAM: 2G
ROM: 16G
HDMI Port: 1
WIFI Antena: Yes
3G/4G Mobile Network: Yes(Optional)
RJ45 Ethernet Port: 10M/100M
USB: 2
Video Format: wmv,avi,flv,rm,rmbv,mpeg,mp4,etc
Speaker: Yes



- **Environment**
Power Input: AC 110-240V
Power Consumption: 45W
Operation Environment: Indoor
Operation Temperature: 0cC-40cC
Operation Humidity: 20%~80%
Screen Surface: Tempered Glass
Enclosure Material: Steel



Sign Accessories



Sign Accessories

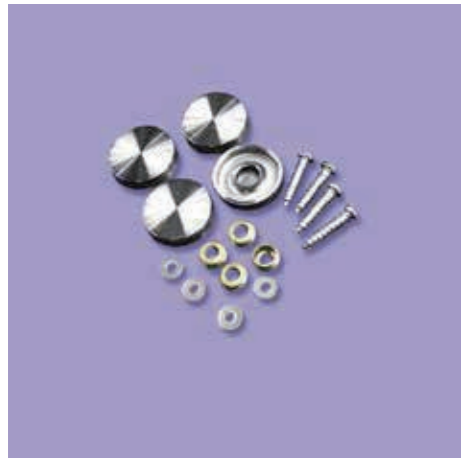

SSC16



MG-EYE



SL-01



BWD-150



SCALE-TCS



FR-01



LB-Wall Bracket



LB-Hanging Bar



DIM-01

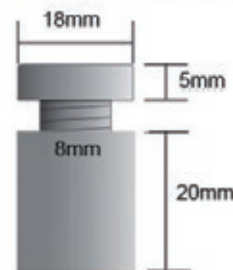

SPS1820

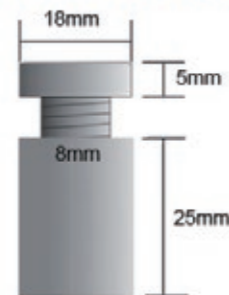

SPS1825

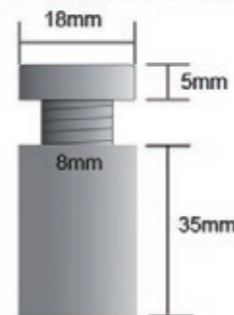

SPS1835

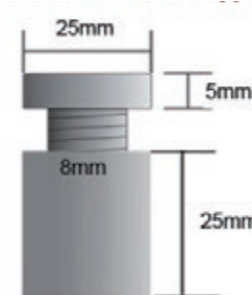

SPS2525

Sign Accessories

Product Code	Product	Size	QTY	Price
SSC16	Screw Cover	16mm	40pcs	\$39
SSC19	Screw Cover	19mm	40pcs	\$49
SSC25	Screw Cover	25mm	40pcs	\$59
MG-EYE	Grommets & Eyelets	6mmD-12mmD	500pairs	\$50-100
SL-01	LED Spot Light	500mm	1pair	\$180
BWD-150	Bubble Wrap Rolls Dispenser	1500mm	1unit	\$359
SCALE-TCS	Digital Platform Scale	-	1unit	\$159
FR-01	Aluminium Cutter	1300mm	1unit	\$60
LB-Wall Bracket	Light Box Wall Brackets	160mm	1pair	\$135
LB-Hanging Bar	Light Box Hanging Bar	1200mm	1pair	\$135
DIM-01	Dimmer	-	1unit	\$120
SPS1820	Panel Mounts	18 x 20mm	6pcs	\$35
SPS1825	Panel Mounts	18 x 25mm	6pcs	\$35
SPS1835	Panel Mounts	18 x 35mm	6pcs	\$39
SPS2525	Panel Mounts	25 x 25mm	6pcs	\$39



DST-4910

3M VHB 4910 Double-sided Tape | Clear Acrylic Tape 1.0mm Thick | Super Sticky

3M VHB 4910 is a 1.0mm thick transparent acrylic adhesive, with strong adhesive force, professional for the long-lasting adhesion of transparent materials such as glass, organic glass, acrylic, etc., waterproof and high temperature, short-term high temperature resistance 149 °C, long-term high temperature resistance 93 °C, no residue.

Thickness /Length/ Width	Price
1.0mm/33M/10mm	\$45
1.0mm/33M/12mm	\$50
1.0mm/33M/15mm	\$60
1.0mm/33M/20mm	\$70
1.0mm/33M/25mm	\$80



3MVHB4941/4950/5952

3M Grey/White/Black Acrylic Foam Tape Double Side Adhesive

1.14mm thick Grey/White/Black closed structure Acrylic foam, high-strength bonded metal, glass, plastic, short-term high temperature 149°C, long-term high temperature resistance 93°C, high tensile force and shear strength and can be used to replace traditional fixation methods such as screws, wilow nails, and spot welding,

Thickness /Length/ Width	Price
1.14mm/33M/10mm	\$40
1.14mm/33M/12mm	\$45
1.14mm/33M/15mm	\$55



DST-9080

3M 9080 Double Sided Tape | Strong Adhesive 0.16mm Thick | Super Sticky 50M

- Heat-Resistant
- Strong adhesive
- Strong tensile strength
- Suitable for irregular surface because of flexibility
- High level of initial tack and good adhesion to a wide variety of surfaces.

Thickness /Length/ Width	Price
0.16mm/50M/15mm	\$25

Buy in Bulk, please contact us for wholesale price

Equipment & Tools

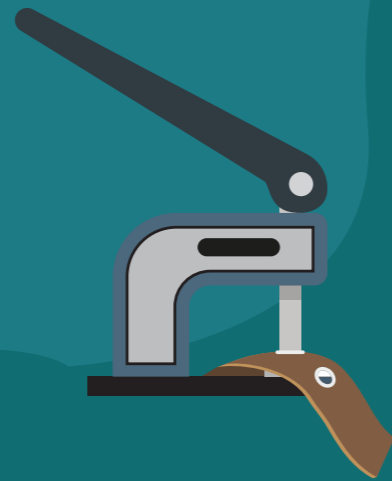
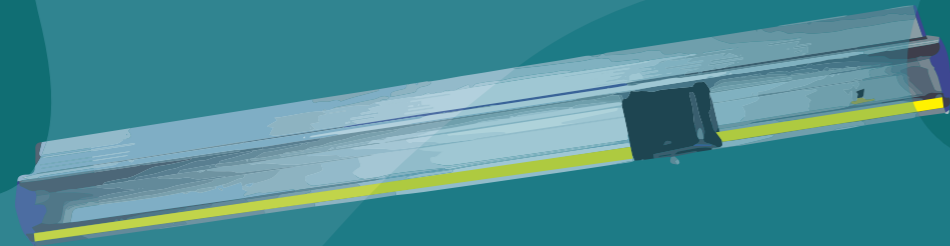
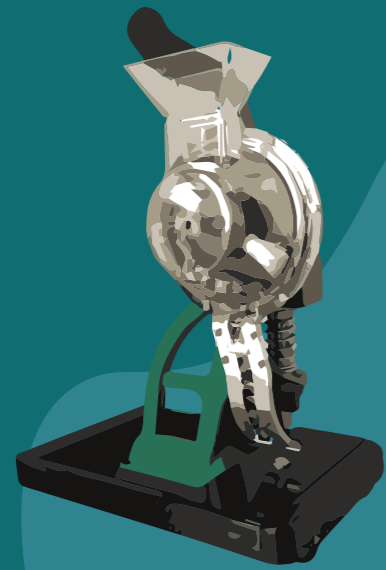

Laminating Machine

1.3M(51")/1.6M (63") Manual Wide Format Roll Cold Laminating Machine



Bracket with Reinforced Design



High Quality Rubber Roller



Rubber Roller Height Adjustment



Manual Lamination



- **Max.working width** 1300mm/1600mm
- **Max.substrate thickness** 20mm
- **Pastern roller lift height** ≤20 mm
- **Application** Indoor/outdoor AD and photograph laminating
- **Gross Weight** 65/72KG
- **Packing Size** 1500x380x430mm/1800x380x430mm

Working Width	Price
1300mm	\$900
1600mm	\$1100



LM-M01

1.6M (63")Premium Manual Wide Format Roll Cold Laminating Machine



LM-M03



- **Max.working width** 1600mm
- **Max.substrate thickness** 20mm
- **Pastern roller lift height** ≤20 mm
- **Application** Indoor/outdoor AD and photograph laminating
- **Gross Weight** 90KG
- **Packing Size** 1930mm x 520mm x430mm

Working Width	Price
1600mm	\$1600

Laminating Machine

1.6M (63") Electrical Wide Format Roll Cold -Laminator, Laminating Machine



LM-M02

- **Max. Laminating width** 1600mm
- **Max. Laminating thickness** 20mm
- **Speed range** 0-7000mm/min
- **Power Supply** AC110, 220V/50, 60Hz
- **Power** 50W
- **Dimensions(LxWxH)** 180x40x40cm
- **Weight** 110kg
- **Application** Indoor/outdoor AD and photograph laminating

Working Width	Price
1600mm	\$1600

1.63M (64") 1700F5 Semi-auto Warm Laminating Machine – LAMINTING & CUTTING

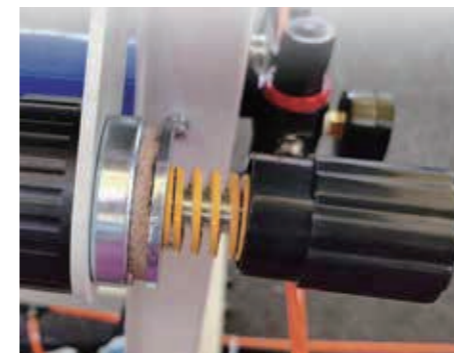
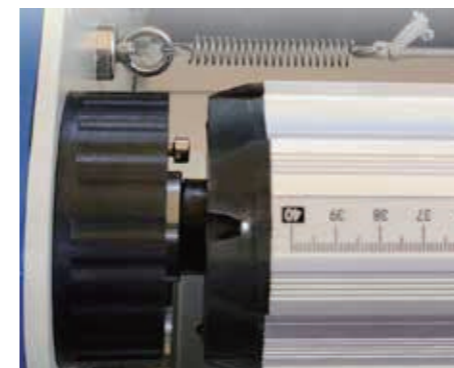

LM1700-F5

- **Max.working width** 1630mm/64"
- **Max lamination thickness** 23mm/0.9"
- **Max speed** 6m/min
- **Max temp** 60°C/140°F
- **Up and down** Hand Crank
- **Heating** Infrared
- **Warm up time** 5-10 min
- **Power consumption** 0.5-0.8kw/h
- **Power input** 1400W
- **Volt** 110V/220V
- **Net Weight** 150KG

Working Width	Price
1630mm	\$5900



Sign Equipments

Laser Engrave Machine | WMY-2513 Flatbed Laser

The WMY-2513 is a VOLASER for professional large-scale cutting. You can cut many non-metal materials, such as MDF, Acrylic, Bamboo, Cloth, Plastic, and more. Leather, High-power tubes are not suitable for engraving

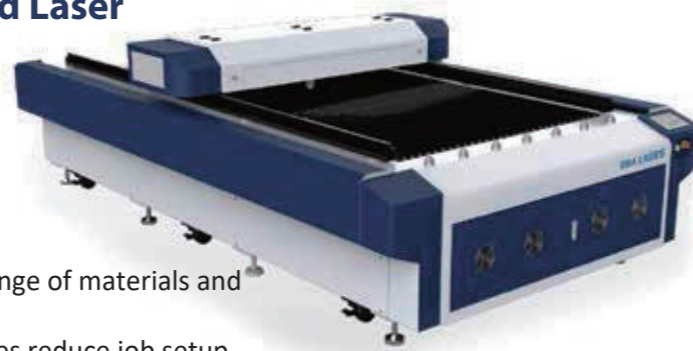

WMY-2513

● Features

- 3rd generation high-speed CO² laser
- Long-life tube (>10000 hours)
- Imported Lenses and mirrors
- High quality belts
- High-precision stepper motors
- Precision X-Y-Z-Axis control
- 2mm steel used in body construction
- Low maintenance, high reliability
- Quiet and clean cutting
- Shipped to you as a completely pre-assembled and factory-tested system

● Advantages

- Cuts a wide range of materials and thicknesses
- No tool changes reduce job setup time
- Produces a high-quality cut reducing secondary finishing operations and associated costs
- Low electrical consumption
- Perfect for short-run or just-in-time production

MW Transformer



MW-320

● Features

- Constant Voltage + Constant Current mode output
- Metal housing with class I design
- Built-in active PFC function
- IP67/IP65 rating for indoor or outdoor installations
- **Function options:** output adjustable via potentiometer; 3 in 1 dimming
- Typical lifespan > 62,000 hours

Product Code	Capacity	Price
MW-75	75W	\$70
MW-150	150W	\$90
MW-240	240W	\$120
MW-320	320W	\$180

Sliding 1800mm Corflute Board Cutting Ruler, Large Format Trimming Ruler

- **Length:** 1800mm/2600mm
- **Material:** Industrial aluminum alloy, strong and durable
- **Cutting thickness:** up to 10mm
- **Applicable materials:** PP Paper, Thin PVC, Foam Board, Corflute Panel, PET Film, Vehicle Wrap, Adhesives, Photo Paper or other rolled materials

1800mm

\$315

2600mm

\$550

Large Format Trimming Ruler | Aluminum Extrusion Trimmer C

- **Size:** 1800mm/2600mm
- **Cutting thickness:** up to 10mm
- **Ideal for cutting:** digital prints, vinyl, films, paper & cardboard
- Optional extended squaring arm for improved accuracy

Size	No Stand	With Stand
1800mm	\$1200	\$1550
2600mm	\$1650	\$1950



TIMEER-C

Sign Equipments

Eyelets Puncher Machine/ Grommet Alloy Ring Punch Press Machine

- Manual grommet machine
- Made in cast iron, painted
- Comes with 500 pairs eyelets (hole diameter: 10mm) and 10mm die/head which will fit 10mm eyelets only
- **Options for additional die:** 6mm/8mm/10mm/12mm
- **Packing size:** 40x30x20cm
- **Weight:** 4kg

Price

\$245



MG-MA

Size	Eyelets	Die
6mm Copper	\$55	\$50
8mm Silver	\$55	\$50
10mm Copper/Silver	\$60	\$50
12mm Copper/Silver	\$65	\$70
10mm Stainless Steel	\$80	-
12mm Stainless Steel	\$100	-



MG-SA

Eyelets Puncher Machine/Semi-automatic Grommet Machine

- Ideal for craft and industrial use; Applicable for banners, signs, awnings, posters, curtains, digital printing, clothing, bags, shoes and more.
- Simple structure and high efficiency, convenient and easy to use
- Automatic grommet feeding and will not buckle
- 1000pcs of eyelets included (10mm).

Price

\$335

4-Worktable Pneumatic /Hydraulic Heat Press Machine

- **Control panel:** intelligent instrument and digital display of temperature and time, the readout temperature tolerance of which is $\pm 2^\circ$
- **Pneumatic device:** with electric rotation automatic control, high printing speed, high accurate performance, its pressure can be 8kg/cm²
- **Operation mode:** it adopts automatic motor rotation, saving time and labor, and it's convenient for operation.
- **Movable heating plate:** the upper plate is movable and the lower plate is fixed which ensure the garment stays well.
- **Silicone pad:** the silicone pad can endure high temperature even reach 390°C and will not change the shape.
- **Voltage:** 240V
- **Power:** 2800W

Pneumatic

\$9900

Hydraulic

\$11500



HEATPRESS-4S

Double-sided, Self-healing Cutting Mat

- **Material:** PVC
- **Thickness:** 3mm

Size	Price
900 x 1200mm (Roll Pack)	\$99
900 x 1200mm (Flat Pack)	\$135
1200 x 2400mm (Roll Pack)	\$300



CM-01

Exhibition & Display

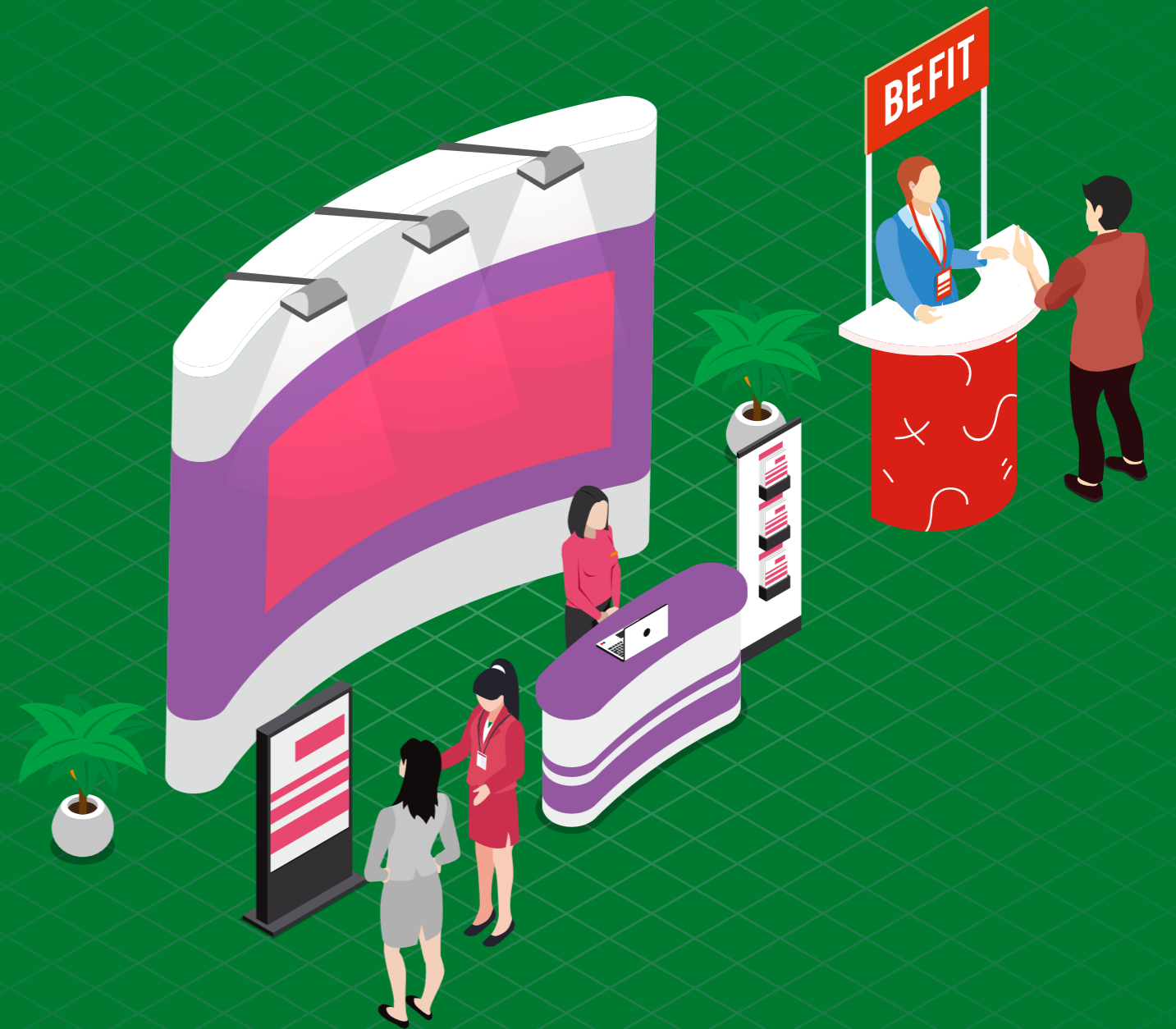

Expo Rigging Banner



HB-Cube

Expo Ceiling Banner

- Tension Fabric Hanging Banner is a great way to increase your message and brands visibility at trade shows and events, helping potential clients find the location of your trade show booth from any position in the trade show area.
- Attract attention to your stand
- Full colour printing on stretch fabric with a zip around the edge
- Can be single sided printing or double sided printing
- Include aluminum frame and rigging points
- Easy to install, lightweight and very impressive
- Carry bag is included

HB-Cube Size	Price
800 x 600 x 600mm	\$750
1000 x 800 x 800mm	\$850
1400 x 1200 x 1200mm	\$1150
800 x 800 x 800mm	\$850
1000 x 1000 x 1000mm	\$950
1000 x 1000 x 1000mm	\$1350



HB-C



HB-Sq



HB-Tri

Product Code	Size	Single Sided Printing	Double Sided Printing
HB-C	2400mmD x 1000mmH	\$990	\$1450
HB-C	3000mmD x 1000mmH	\$1200	\$1650
HB-C	3600mmD x 1000mmH	\$1450	\$1950
HB-Sq	2400mmL x 2400mmW x 1000mmH	\$990	\$1450
HB-Sq	3000mmL x 3000mmW x 1000mmH	\$1200	\$1650
HB-Sq	3600mmL x 3600mmW x 1000mmH	\$1450	\$1950
HB-Tri	2400mmL x 2400mmW x 1000mmH	\$990	\$1450
HB-Tri	3000mmL x 3000mmW x 1000mmH	\$1100	\$1650
HB-Tri	3600mmL x 3600mmW x 1000mmH	\$1200	\$1750

Media Walls



POP-PVC-C



POP-PVC-S



Spot lights

POP-PVC Size	No Hardcase Top	1xHardcase Top	2xStandard Pull Up Banner	2xLuxury Pull Up Banner
3 x 3m Curve	\$1700	\$1780	\$1960	\$2110
3 x 3m Straight	\$1700	\$1780	\$1960	\$2110
3 x 4m Curve	\$1800	\$1880	\$2060	\$2210
3 x 4m Straight	\$1900	\$1980	\$2160	\$2310

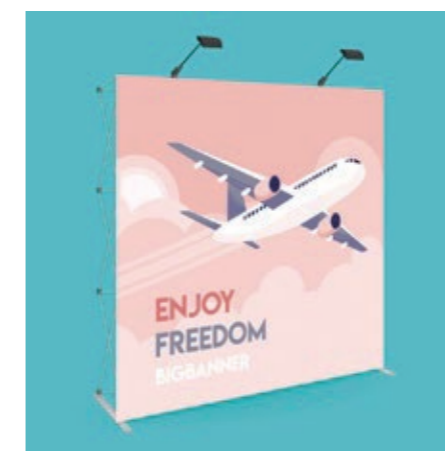

POP-12



POP-2

POP-12 Size	Price
2250 x 2250mmH	\$850
3000 x 2250mmH	\$1050

POP-2 Size	Price
2250 x 2250mmH x 300mmD	\$850
3000 x 2250mmH x 300mmD	\$1050

Pop Up Stand

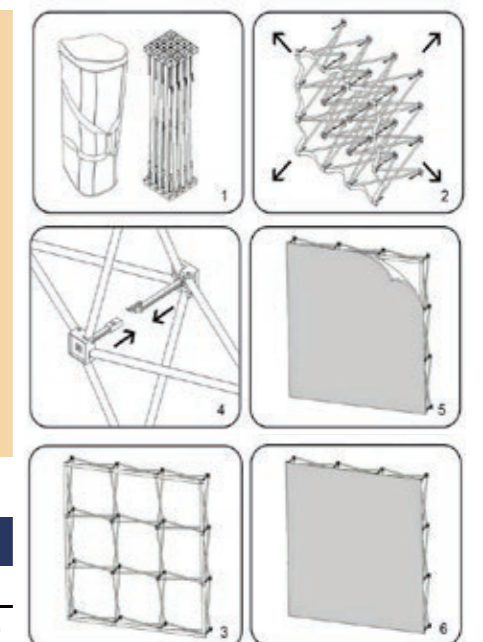



WB-S



WB-S Size	Price
3m x 3mH x 0.3mD	\$1950
6m x 3mH x 0.4mD	\$3150
9m x 3mH x 0.4mD	\$4150
6m x 4mH x 0.5mD	\$3750
9m x 4mH x 0.5mD	\$4950

Premium Fabric Wrapped Wall Box

This is a super Luxury Fabric made Wall. 30-40cm depth makes it suitable for both indoor and outdoor events. This stylish Wall banner is commonly used by Luxury Brands as it brings most of attention of guests in the events.

- **Hardware:** Perfect Anodized aluminum pole, diameter 32mm, thickness 1.5mm, making the stand very stable and durable.
- **Graphic material:** Polyester fabric
- Box design presents a high quality brand & image
- Tool-free assemble, fast and convenient
- Oxford bag packing

3m x 3m version is suitable for a 3m display space. However, we can custom to whatever size to fit your display demand. The biggest one we've done was 4.5m tall x 15m in width, 90cm in depth. That was a great experience for supplying this Monster Wall, and the best point is, unlike the building timber walls, this Aluminum structured wall is reusable, easy to pack up and storage for next event, thus a worthy investment.

3D Backwall



Display Set Up

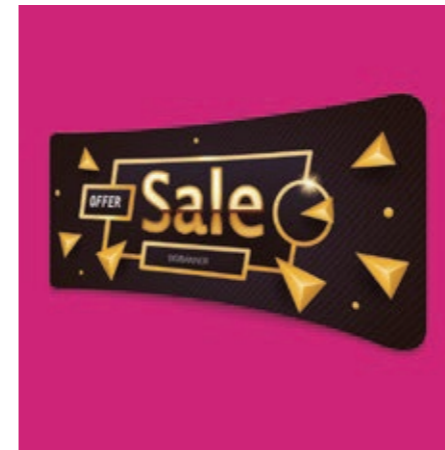
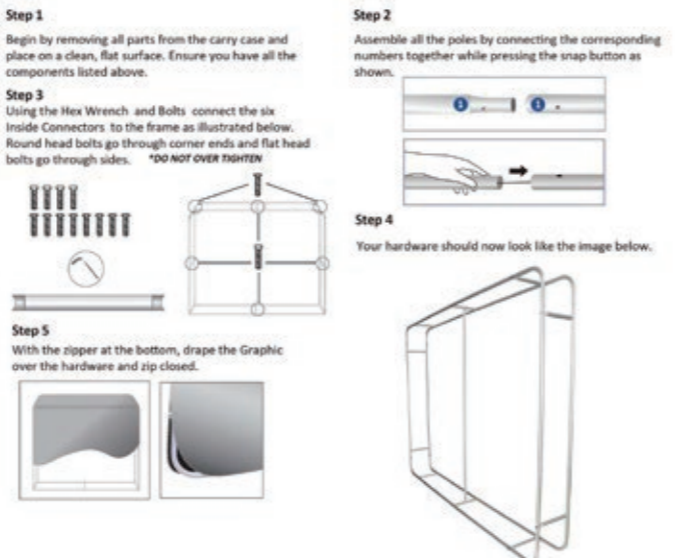

FW-2.3X6m-C



FW-2.3X6m-S



FW-2.3X3m

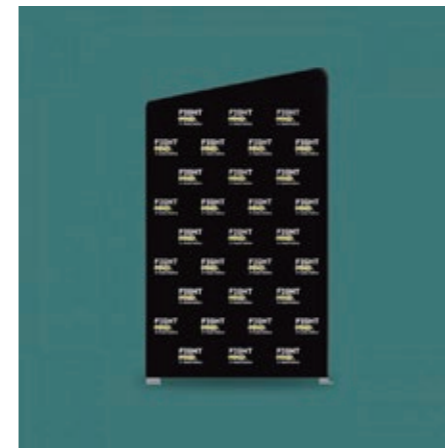

FW-2.3x1.5mU



FW-2.3x1.5m



FW-2.3x1.5mD



FW-1x0.9m

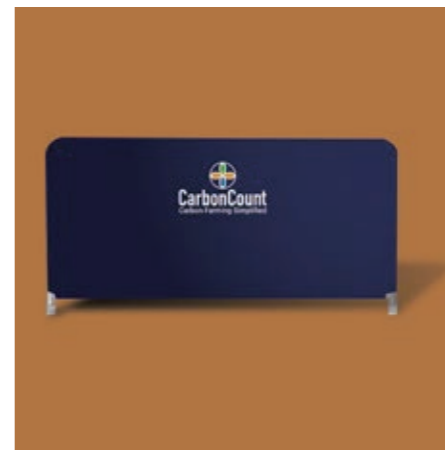

FW-2x0.9m



FDS-0.85x2m



FW-2X2m Round

FW- Size Single Side

FW- Size	Single Side
1000 x 900mmH	\$159
1500 x 900mmH	\$189
2000 x 900mmH	\$209
1500 x 2300mmH	\$390
2300 x 2000mmH	\$490
2400 x 2300mmH	\$590
3000 x 2300mmH	\$590
4000 x 2300mmH	\$890
5000 x 2300mmH	\$990
6000 x 2300mmH	\$1190

FDS- Size Single Side

FDS- Size	Single Side
850 x 1500mmH	\$169
850 x 2000mmH	\$199
1200 x 1500mmH	\$209
1200 x 2000mmH	\$239

FWU/D- Size Single Side

FWU/D- Size	Single Side
1500 x 2300mmH	\$590

FW-Round- Size Single Side

FW-Round- Size	Single Side
2000mmD	\$1390

Flag Banners



FLB-FT

Printing	Size	Flag Only	Whole Set
Single Side	XSmall 1.8m	\$39	\$60
	Small 2.3m	\$49	\$75
	Medium 3.0m	\$69	\$100
	Large 4.0m	\$99	\$155
	XLarge 4.6m	\$119	\$185
Double Side	XSmall 1.8m	\$69	\$80
	Small 2.3m	\$89	\$110
	Medium 3.0m	\$129	\$155
	Large 4.0m	\$179	\$225
	XLarge 4.6m	\$199	\$265

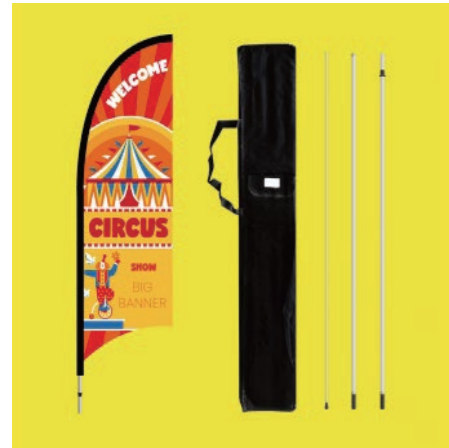

FLB-FF

Printing	Size	Flag Only	Whole Set
Single Side	XSmall 2.0m	\$39	\$65
	Small 2.5m	\$49	\$75
	Medium 3.5m	\$69	\$100
	Large 4.7m	\$99	\$155
Double Side	XSmall 2.0m	\$69	\$100
	Small 2.5m	\$89	\$110
	Medium 3.5m	\$129	\$155
	Large 4.7m	\$179	\$225



FLB-FR

Printing	Size	Flag Only	Whole Set
Single Side	Small 2.2m	\$69	\$95
	Medium 3.0m	\$89	\$120
	Large 4.3m	\$119	\$175
Double Side	Small 2.2m	\$109	\$130
	Medium 3.0m	\$149	\$175
	Large 4.3m	\$199	\$245

Product	Price
Silver Foldable Base	\$45
Premium Spike Base	\$35
Black Premium Cross Base	\$45*
V-shape Car Tyre Base	\$50
Wall Brackets (0°, 30°, 90°)	\$25
5kg Heavy Duty Square Base	\$50*
10kg Heavy Duty Square Base	\$65*

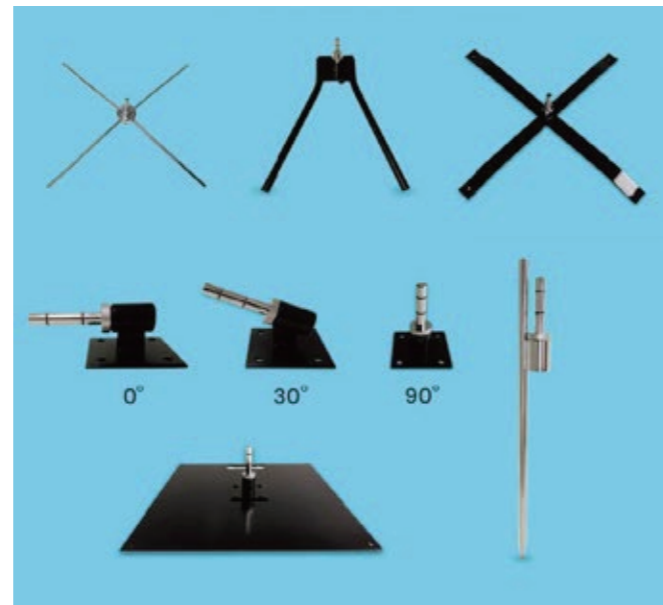

Flag Banners



FLB-B

Printing	Size	Flag with Pole	Add Bag
Single Side	Small 2.3m	\$60	\$72
	Medium 2.9m	\$85	\$97
	Large 3.7m	\$105	\$117
	XLarge 4.7m	\$125	\$137
Double Side	Small 2.3m	\$95	\$107
	Medium 2.9m	\$125	\$137
	Large 3.7m	\$145	\$157
	XLarge 4.7m	\$180	\$192



FLB-B

Printing	Size	Flag with Pole	Add Bag
Single Side	Small 2.8m	\$60	\$72
	Medium 3.2m	\$85	\$97
	Large 4.2m	\$105	\$117
	XLarge 5.2m	\$125	\$137
Double Side	Small 2.8m	\$95	\$97
	Medium 3.2m	\$125	\$137
	Large 4.2m	\$145	\$157
	XLarge 5.2m	\$180	\$192

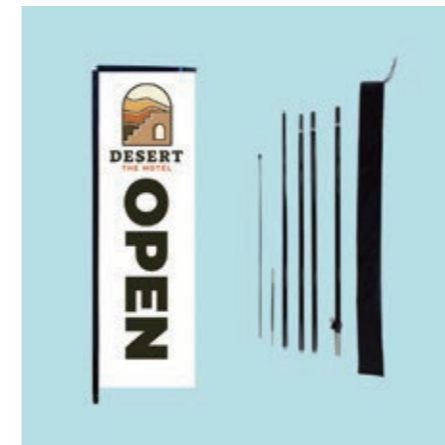

FLB-B

Printing	Size	Flag with Pole	Add Bag
Single Side	Small 1.2m	\$70	\$82
	Medium 2.1m	\$100	\$112
	Large 3.1m	\$115	\$127
	XLarge 4.1m	\$125	\$137
Double Side	Small 1.2m	\$95	\$107
	Medium 2.1m	\$125	\$137
	Large 3.1m	\$150	\$165
	XLarge 4.1m	\$160	\$172



Product	Price
10/15kg Water Bag	\$12/\$16
Standard Spike	\$20
Tent Mounting Base	\$65
Silver Fold Base + Water Bag	\$55
Black Cross Base + Water Bag	\$55
20L Heavy Duty Water Tank Base	\$65
Fence Base	\$55

Commercial Marquees



FM3x3S4



FM3x3S1



FM3x3S2



FM3x3S3



FM3x3S5

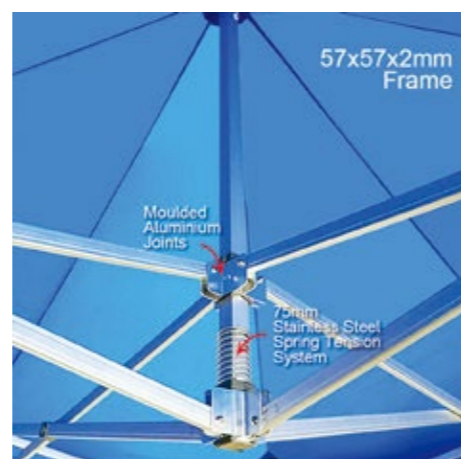

Commercial Marquees

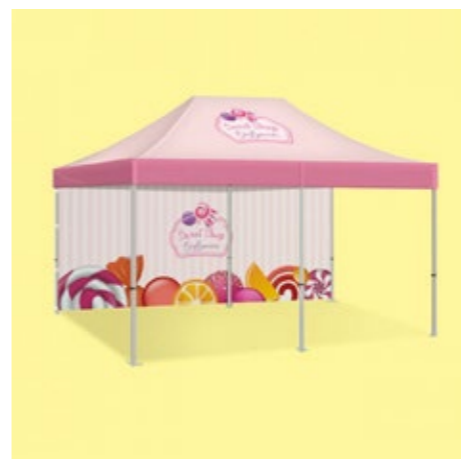

FM3x6S2

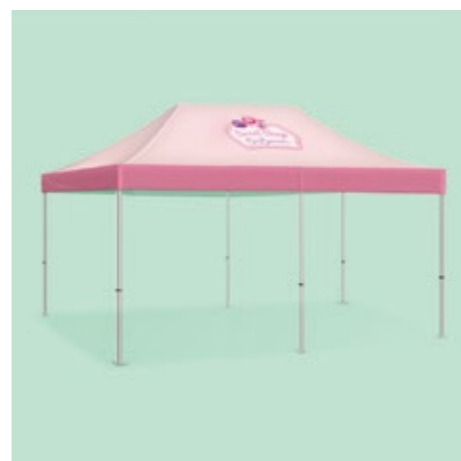

FM3x6S1



FM3x6S3



FM3x6S4



FM3x4.5S3



Product Code	Price
WB-2	\$39

Product Code	Frame Size	Tube Thickness		
		4.5x4.5x1.0mm	4.5x4.5x1.8mm	5.7x5.7x2.0mm
FM3x3S1	3 x 3m	\$750	\$950	\$1150
FM3x3S2	3 x 3m	\$950	\$1150	\$1350
FM3x3S3	3 x 3m	\$1350	\$1550	\$1750
FM3x3S4	3 x 3m	\$1200	\$1400	\$1600
FM3x3S5	3 x 3m	\$1350	\$1350	\$1350
FM3x4.5S3*	3 x 4.5m	\$1750*	-	-
FM3x6S1	3 x 6m	\$1150	\$1450	\$1750
FM3x6S2	3 x 6m	\$1550	\$1850	\$2150
FM3x6S3	3 x 6m	\$1950	\$2250	\$2550
FM3x6S4	3 x 6m	\$1750	\$2050	\$2350

Package Includes:

- 1 X Marquee frame
- Full colour printed marquee cover
- 4 X pegs & ropes
- 1 X carry bag with wheels
- Aluminium frame with plastic connector and alu feet.
- **Cover:** 600D polyester with PU coating.

Please check this product on www.bigbanner.com.au

Cafe Barriers | Wind Break



CB-1mx1m-B

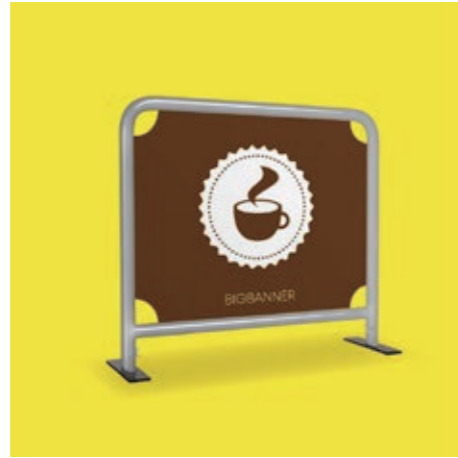

CB-1mx1m-S



CB-1mx1m-SQ



CB-2mx1m-B

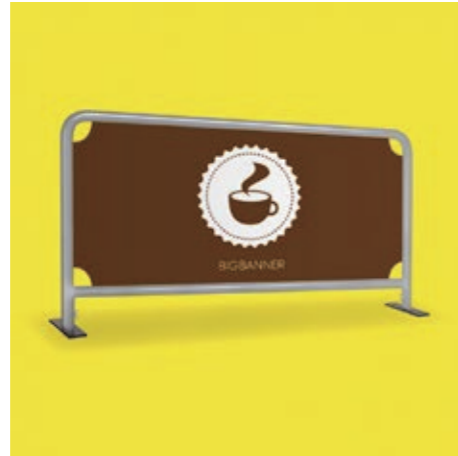

CB-2mx1m-S



CB-2mx1m-SQ



CB-1mx1.5m



CB-2mx1.5m



CB-2n2-B



UMB-2x2-E



UMB-2x2



UMB-3x3



WB-10



UMB-B-45



Feet-D



In Ground Socket

Product Code	Frame Size	Frame Only	Incl. SS Print	Incl. DS Print
CB-1mx1m-B/S	1000x940mm	\$135	\$195	\$215
CB-2mx1m-B/S	2000x940mm	\$185	\$265	\$295
CB-1mx1m-SQ	1000x940mm	\$145	\$205	\$225
CB-2mx1m-SQ	2000x940mm	\$195	\$275	\$305
CB-2n2-B/S	1m+2m+2m+1m	\$620	\$900	\$1,000
CB-2n2-SQ	1m+2m+2m+1m	\$660	\$940	\$1,040

Product Code	Frame Size	Frame Only	SS Print / Blank PVC*	Incl. DS Print
CB-1mx1.5m	1000x1500mm	\$270	\$495	\$585
CB-2mx1.5m	2000x1500mm	\$360	\$640	\$735
CB-2n2-1.5H	1m+2m+2m+1m	\$1,260	\$2,250	\$2,600

Blank PVC* means blank colour at the bottom and clear PVC film at the top.

Feet are not included in the above prices and can be purchased separately.

Cafe Barrier full colour printing on vinyl [Printing Only, No trim No finish]

Barrier Size	Graphic Size	SS Printing	DS Printing
2meter	1950x760mm	\$80	\$120
1meter	950x760mm	\$60	\$80

Cafe Barrier full colour printing on vinyl [Pocket sewing x 4 edge, Corner cut x 4]

Barrier Size	Graphic Size	SS Printing	DS Printing
2meter	1950x760mm	\$120	\$160
1meter	950x760mm	\$90	\$110

Additional labour cost of \$30 per barrier for Cafe Barrier reskin work

Product Code	Description	Price
Feet-D	Double Feet	\$29
Feet-S	Single Feet	\$19
Feet-1.5H	Single Feet for 1.5m barrier	\$24
UMB-B-45	450mm base for umbrella	\$95
UMB-B-60	600mm base for umbrella	\$110
WB-10	10kg weight bag	\$39.5
WB-15	15kg weight bag	\$54.5
SOK-SS40	In ground socket single sleeve for cafe barrier	\$185
SCK-DS40	In ground socket double sleeve for cafe barrier	\$195
SCK-UMB50	In ground sockets for umbrella	\$199

Product Code	Umbrella Size	Frame Only	Incl. Cover (from)	Incl. CMYK Print
UMB-2X2-E	2.0x2.0m_2.44H	\$120	\$195	\$395
UMB-2X2	2.1x2.1m_2.75H	\$195	\$355	\$595
UMB-3X3	3.0x3.0m_3.0H	\$355	\$625	\$750

CMYK Print: full colour dye-sub printing

Prices for digital heat transfer & screen print refer to page 14



UMB-2x2-E

Square Economic Umbrella Hexagon Aluminium Frame | Valance (2x2m)

- Canopy size 2mx2m with full colour customized printed logo, text or photos.
- 190mm H full colour customized printed valance included.
- Anodized aluminium frame which is lightweight and completely rust-free.
- The frames come with 4 easy-slide height-adjustment system.
- 2-year warranty on frames.
- Bases are selling separately.
- Base comes with round tube, will not 100% match the rod of the umbrella. We recommend you to use cardboard or cloth to wrap and secure the rod to the base sleeve.
- Inspections can be arranged in our Melbourne warehouse showroom.

Product Code	UMB-2x2-E
Umbrella Size	2.0 x 2.0m_2.44H
Black Canopy + Frame + 4 Logo on Top	\$385
Black Canopy + Frame + 4 Logo on Valance	\$345
Full Colour Printed Canopy + Frame	\$415

Product Code	Description	Size	Price
UMB-B	Umbrella Base	450 x 450mm	\$95
UMB-B	Umbrella Base	600 x 600mm	\$115

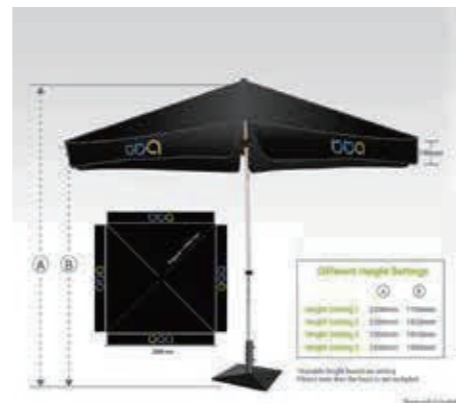

UMB-B



UMB-2x2



UMB-3x3



Colour Choice



WB-1



InGrd Socket

The Instant Shade commercial-grade high quality aluminium-framed "market" umbrellas are the ideal shade solution for your outdoor living space.

Commercial Quality and Great Value

Perfect for commercial or residential use to protect you from the harsh Australian sun. The same umbrellas used by cafes, restaurants and resorts all over Australia are also available for your own deck, courtyard, balcony and pool areas at home.

The Frame

The umbrella frames are stylish anodised aluminium which is lightweight and completely rust-free. The frames come with a 2-year warranty.

Weather, Water and UV Resistant Canopy

The canopies are made of water repellent and UV-resistant long-lasting materials. Canopies come with a variety of stylish colours as well.

Product Code	UMB-3x3
Umbrella Size	3 x 3m_3H
Polyester Canvas + Frame	\$630
Polyester Canvas with Valance + Frame	\$710
Acrylic Canvas + Frame	\$730
Acrylic Canvas with Valance + Frame	\$810

Product Code	UMB-2x2
Umbrella Size	2.1x2.1m_2.75H
Polyester Canvas + Frame	\$390
Polyester Canvas with Valance + Frame	\$450
Acrylic Canvas + Frame	\$435
Acrylic Canvas with Valance + Frame	\$495

Product Code	Description	Weight	Price
WB-1	Weight Bag Sand Bag	10kg	\$38.5
WB-1	Weight Bag Sand Bag	15kg	\$49.5
InGrd Socket	Umbrella Inground Socket & Sleeves	-	\$265



1300 550 168

www.bigbanner.com.au



*All prices in this catalogue are GST EXCLUSIVE.
Prices are subject to change without notice. BBA reserves all rights for final explanation.

📍 Sydney
340 Chisholm Rd
Auburn
NSW 2144

📍 Melbourne
71 Strzelecki Ave
Sunshine West
VIC 3020

📍 Brisbane
37 Smallwood St
Underwood
QLD 4119